

Your competent solution



Solutions for effective
product display



VKF Renzel

VKF Renzel Danmark ApS • H.P. Christensens Vej 1 • DK 3000 Helsingør
Tlf. nr.: +45 49 21 08 00 • www.vkf-renzel.dk • info@vkf-renzel.dk



Main Hub Germany



VKF RENZEL DANMARK APS
H.P. Christensens Vej 1
3000 Helsingør
Danmark



+45 49 21 08 00



info@vkf-renzel.dk



www.vkf-renzel.dk



Hygiene & Safety

| Hygiene & Safety |



1. Hygiene & Safety 3-12



2. Slatwall System FlexiSlot® | Shopfitting 13-20



3. EasyCubes 21-28

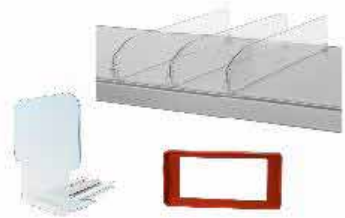

4. Price Labelling | Shelf Optimisation 29-36



5. Product Holders | Frames | Advertising Stands | Digital Signage 37-52



6. Outdoor Advertising 53-58



7. Giveaways | Name Badges 59-62



1





Hygiene Station "Score" with Steripower Sanitiser Device

The aluminium and steel display provides an optimal stand function for the high quality Steripower hand sanitiser "White Edition". The disinfectant dispenser works with the help of a sensor that delivers a burst of spray during contactless use. This helps you avoid contact surfaces where pathogens and bacteria can adhere. The spray burst can be adjusted in intensity over 10 levels. The levels can be adjusted from 0.5 ml to 5 ml. The dispenser is suitable for disinfectant bottles up to 1000 ml. Corresponding bottles are available in our online shop.

A collection tray for excess liquids is integrated in the hand sanitiser dispenser. Absorbent medical pads, which you can order under our accessories with the Steripower kit, can be inserted into this collection tray. The practical and large opening offers plenty of space to cover both hands simultaneously with a spray mist.

In addition, the high quality Steripower device is equipped with a pre-charged battery. The corresponding charger is available with the Steripower kit (59.2495.12) in our range of accessories. It is not included in the delivery and is required for continuous use of the sanitising device.

Material: aluminium / steel / plastic;
Colour of upright: silver anodised;
Colour of base: silver similar to RAL 9006;
Size of base: 700 x 450 mm (W x T); Total height: 1500 mm
51.0129.19

Compatible with all liquid hand sanitisers!



Steripower Kit

Use the "Score" hygiene stand in entrance areas with the matching Steripower Kit. Included in this kit you get practical and necessary accessories for everyday use. The included 12 absorbent medical pads can be inserted into the collection tray of a hygiene display to absorb the excess liquid. In addition, the Steripower Kit includes an external charger with power supply and charging cable as well as a rechargeable battery (12V - 7.0 AH).

Features: 12x Medical Pads, 1x charging cable;
Features 2: 1x external charger, 1x battery (12V - 7.0 AH)
59.2495.12

Aktuelle priser findes på vores Webshop

Hygiene Stand "Sensor-Tondo"

Our hygiene stand "Sensor Tondo" is ideal for high traffic customer areas such as entrance areas in supermarkets, pharmacies and banks. The operation is contactless thanks to the integrated sensor. Simply hold your hands under the sensor for 2 seconds and your hands are sprayed with sanitiser. In addition, the dosage can be adjusted between 3 levels. This guarantees professional and hygienic use at all times. The liquid sanitiser can be easily filled into the integrated container. Through the insert frame in A4 landscape format placed above the dispenser, you can also draw your customers' attention to other important behaviours, such as the social distancing.

Frame material: plastic; Insert size: A4 (210 x 297 mm);
Orientation: landscape; Frame colour: grey;
Type of cover sheet: anti-reflective, UV stabilised;
Frame material: metal; Colour of frame: silver;
Material of base: metal; Base diameter: 320 mm;
Colour of base: silver; Total height: 1770 mm;
Power supply: operation with 6x AA battery or mains adapter;
Features: incl. sanitiser dispenser with sensor 1L;
Model: sensor controlled spraying technology;
Features 2: without sanitiser; Features 3: without batteries
50.0340.1



Corresponding sanitiser for our hygiene stand can be found in our online shop.
There you can also find practical hand sanitiser gels.

Større udvalg findes på : www.vkf-renzel.dk

1



Spit Shield "Construct"

In the areas where seller and customer meet in direct contact, special hygiene regulations must be observed in the current situation. The spit shield "Construct" is optimally suited to protect employees and customers. The aluminium square tube holds the transparent plastic panel. With a size of 1000 mm in width and 500 mm in height, this offers exactly the right hygiene protection. The entire frame has a height of 750 mm, which gives the possibility of a pass-through of 250 mm in the lower area. We recommend cleaning the material with a soft microfibre cloth and warm soapy water.

Frame material: aluminium / plastic;
Profile type: square tube, 30 x 30 x 1,5 mm;
Frame colour: silver anodised / black; Total depth: 250 mm
51.0313.8

Would you like the product in a different format?
No problem. Please contact us!

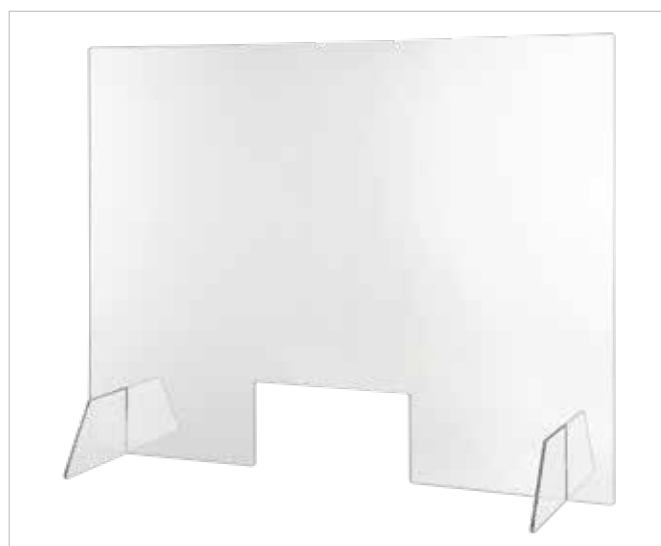

Sneeze Guard "Alba"

The sneeze guard Alba is made up of 3 parts which slot together and can be disassembled again if necessary and stored in little space. The opening has a size of: 300 x 150 mm (width x height)

Material: plastic; Colour: crystal clear

Width: 1000 mm; Height: 750 mm

60.0605.6

Width: 750 mm; Height: 1000 mm

60.0605.7

Width: 500 mm; Height: 750 mm

60.0605.8



Aktuelle priser findes på vores Webshop

1



Ceiling Suspension "Protective Screen" made of highly transparent acrylic

Material: acrylic; Material thickness: 2 mm; Colour: crystal clear;
Edge quality: saw notch; Number of holes: 2; Hole diameter: 5 mm;
Hole distance: 100 mm from the side, 10 mm from the top

Version: landscape - width 1000 mm, height: 500 mm

60.0224.833

Version: portrait - width 500 mm, height: 1000 mm

60.0224.834

"VoiceBridge" Intercom

Communicate clearly and effortlessly with your customers. In spite of face masks and hygiene barriers! Our "VoiceBridge" automatically activates and deactivates itself when a customer enters the checkout area or comes to a service counter. A loudspeaker is mounted on each side of the hygiene protection walls. No specialist knowledge is required to install the system: the loudspeakers are equipped with double-sided mirror adhesive tape on the back. Simply peel off the protective film and attach it to the hygiene protection wall. Plug the power supply unit into the socket and you can communicate clearly and effortlessly!

Casing material: plastic; Sizes: 86 x 111 x 18 mm;
Colour: white; Connection: with power supply
10.0540.1



For cleaning of acrylic and transparent plastics we recommend
"Viral Cleaner Acrylic". (60.0004.2). Find it online!

Større udvalg findes på : www.vkf-renzel.dk

7

6

1



Roll Banner "Stick" Partition Wall

The roll banner "Stick" is a classic roll up banner that serves as a spit shield. In the aluminum casing is a PET sheet that can be pulled out. On request this can be printed turning it in to an advertising or information space. As soon as the stand is set up, it protects against sneezing, coughing or breath. The thin PET reduces the transmission of bacteria or pathogens via droplet infection. This provides ideal protection for office staff, customers or service personnel.

Casing material: aluminium; Casing colour: silver;
Height: 2000 mm; Depth: 300 mm; Version: partition;
Features: incl. transparent banner

Width: 850 mm

80.0126.77

Width: 1000 mm

80.0126.72



Aluminium Stretch Frame Partition Wall incl. crystal clear PVC Banner

The partition consists of an aluminium stretch frame, which stands on two stable base plates. It is supplied with a clear banner made of film, which is fitted all around with flat piping. The barrier wall is ideal for implementing distancing rules and separating areas. At the same time, visibility in the room is maintained. This is particularly advantageous where eye contact is important, e.g. in the dining room of restaurants or in consultation meetings. The optical perception of the room is also maintained by the transparency and is not negatively impacted.

Another banner can be clamped into the frame at any time. We would be pleased to offer you a custom printed textile banner or also a sound insulated version.

For cleaning we recommend warm detergent solution.

Frame material: aluminium; Frame colour: silver anodised;
Frame depth: 44 mm; Version: incl. transparent PVC banner
and 2 angle feet

Size: 1000 x 2000 mm (W x H)

15.0219.146

Size: 1300 x 2000 mm (W x H)

15.0219.141

Size: 1700 x 2000 mm (W x H)

15.0219.148

Size: 1800 x 2000 mm (W x H)

15.0219.147

Aktuelle priser findes på vores Webshop

Face Protection Visor

The crystal-clear plastic material allows a good view while the face is fully protected. The sheet has a width of 380 mm and a height of 225 mm and is attached to the head with a hook & loop strap. The strap has a length of 800 mm and can therefore be adjusted to fit any head size without slipping.

The visor is neither personal protective equipment nor a medical product.

Material: PET; Material thickness: 0.5 mm;
Colour: crystal clear; Version: adhesive closure & fleece
is enclosed (800 mm); Weight: 90 g
26.0732.1

1. Remove protective film from both sides

2. Push the visor forward

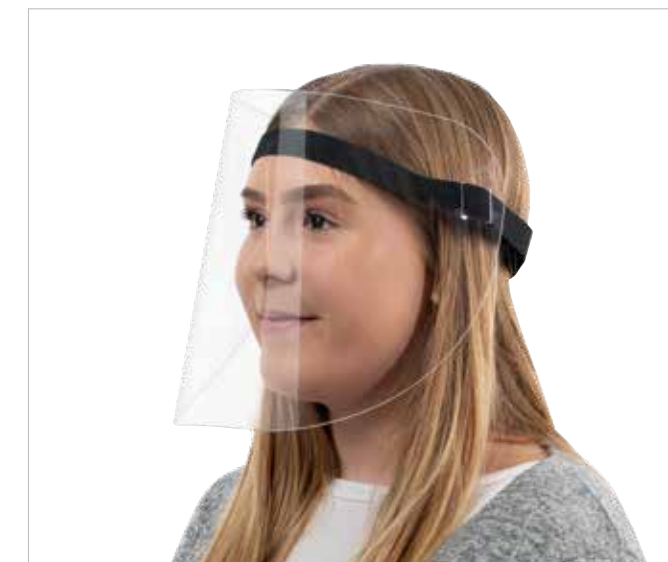

Professional Air Purifier "R150 Silent"

The professional air purifier "R150 Silent" with 3 filter stages and UV-C light frees the air reliably from aerosols, bacteria, pollen and viruses. Particularly suitable for large rooms with high traffic, such as doctors' surgeries, fitness studios, open-plan offices and nurseries.

The device consists of a powerful fan with a 3-stage filter unit. The air is sucked in and passed through a pre-filter past UV lamps and then passes through the built-in HEPA (High Efficiency Particulate Air Filter), which removes aerosols, dust particles, viruses, pollen and bacteria from the air.

Material: aluminium; Surface: powder coated;
Colour: white; Sizes: 393 x 463 x 950 mm (L x W x H);
Room size: up to 150 m²; Separation efficiency: 99,95%;
Filter area: 150 m²; Volume flow: 1062 m³/h;
Designed for: rooms up to 150 m² with a room height of 3 m;
Finish: with infinitely variable power control (0-100%);
Features: with manometer display for filter change;
Power input [W]: 210 W; Voltage [V]: 230 V;
Amperage [A]: 16 A; Weight: 22 kg
10.0537.7



Større udvalg findes på : www.vkf-renzel.dk

1

Ladders

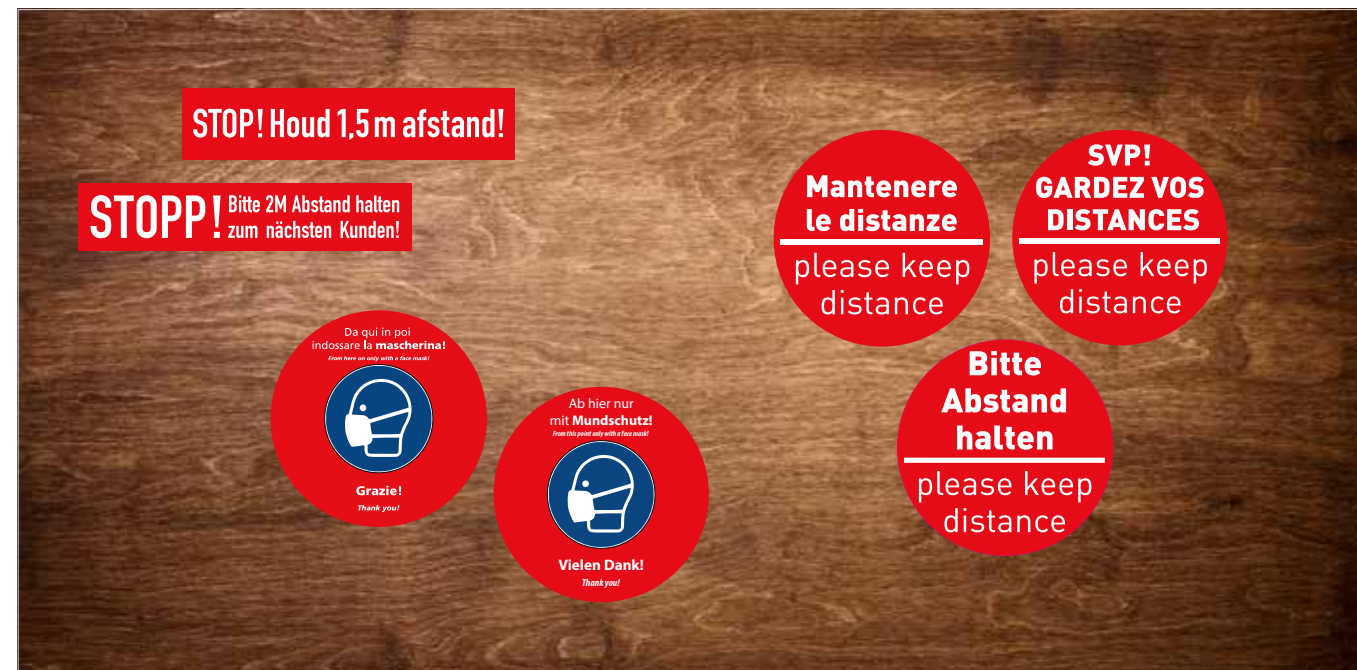

Floor stickers in various designs

High quality floor stickers are the ideal way to provide eye-catching and concise information. Due to the quick application and the high attention they attract, the stickers are a great means for effective floor advertising. At the point of use, you then simply pull the stickers from a film and place them on the floor.

And just like that, you can advertise your products and offers or provide information about safety instructions and opening hours. Floor stickers are available in a wide variety of colours and shapes, which we can print for you. Discover the diverse selection in our online shop or get in touch!



Washable Mat with Logo / Doormat / Customised Imprint

The logo mat is printable in 30 basic colors and can be washed at 50 °. The mats are also available on request in special sizes and colors. All mats are produced with a circumferential rubber edge of approx. 2 cm. The PVC-free NBR back prevents the mats from slipping on smooth surfaces. The mat surface is made of polyamide 6.6 and is B1 fire protection certified. In addition to a high dirt trap capacity, it has a water absorption of 3-4 l / m². The weight of the pile is about 750 g / m² and is about 8 mm high. The costs include printing and design costs. A size tolerance of +/- 3% is possible!

Size: 850 x 1150 mm; Print method: chromo JET
16.0036.7

Logo mats can be made in portrait or landscape format.
Special colours also available on request.

- The associated colour table can be downloaded from our website.
- Pre-printed logo mats with the guidance "Please keep your distance" can be found in our online shop.

Aktuelle priser findes på vores Webshop

Barrier Post "Magnetic"

This barrier stand is characterized by its magnetic strap end piece, which simply sticks to the magnetic surface of the head end piece. In this way a particularly fast and uncomplicated use is possible, e.g. in the catering trade, at events or at the entrance control.

Material: steel; Surface: powder coated; Post colour: black;
Tape colour: black; Tape extends to: 3000 mm;
Tape width: 50 mm; Base diameter: 450 mm;
Total height: 850 mm; Weight: 8.0 kg; Version: magnetic
80.1126.1



Barrier Post "Light"

Material: plastic; Material of base: plastic, can be filled with water or sand; Post colour: black; Tape extends to: 3700mm;
Tape width: 5 cm; Base diameter: 380 mm;
Total height: 970 mm; Weight: 8.0 kg

Tape colour: blue
80.0010.162
Tape colour: black
80.0010.163
Tape colour: red
80.0010.164



Access Control System "Counter"

Easy to install access control system suitable for retail, catering, pharmacies and service providers. The stele is placed on one side of the entrance and a reflector on the opposite side. Once the desired maximum number of people has been set, the system is ready for use without the need to connect to a network or the Internet. As soon as more people than the specified number pass the entrance, the system switches from a green "Go" to a red "STOP" light.

Casing material: aluminium; Colour: silver;
Width: 350 mm; Height: 1200 mm; Depth: 350 mm;
Weight: 14.0 kg; Range of use: for indoor use
89.0048.4



Større udvalg findes på : www.vkf-renzel.dk



Banner Display "Mini"

Material: aluminium; Banner material: PVC;
Size: 230 x 350 mm (W x H); Depth: 80 mm;
Banner size: 210 x 310 mm;
Print: with digital print
80.1102.2

Pre-printed roll banner incl. hygiene guidance can be found in our online shop.



Poster Stand "Info", 32 mm profile, double-sided, with rounded corners, silver anodised

- Click frame incl. polystyrene back panels and anti-reflective, UV-stabilised cover sheets
- RAL powder coated for 1+ pieces
- Custom finishes for 1+ pieces

Version: 2-sided;
Insert size: A1 (594 x 841 mm);
Dispenser size: without;
Total height: 1800 mm
50.0083.2

1. Pictured incl. accessories:
Leaflet Tray 50.0093.24



Corresponding insert with printed hygiene guidance can be found in our online shop.

Aktuelle priser findes på vores Webshop

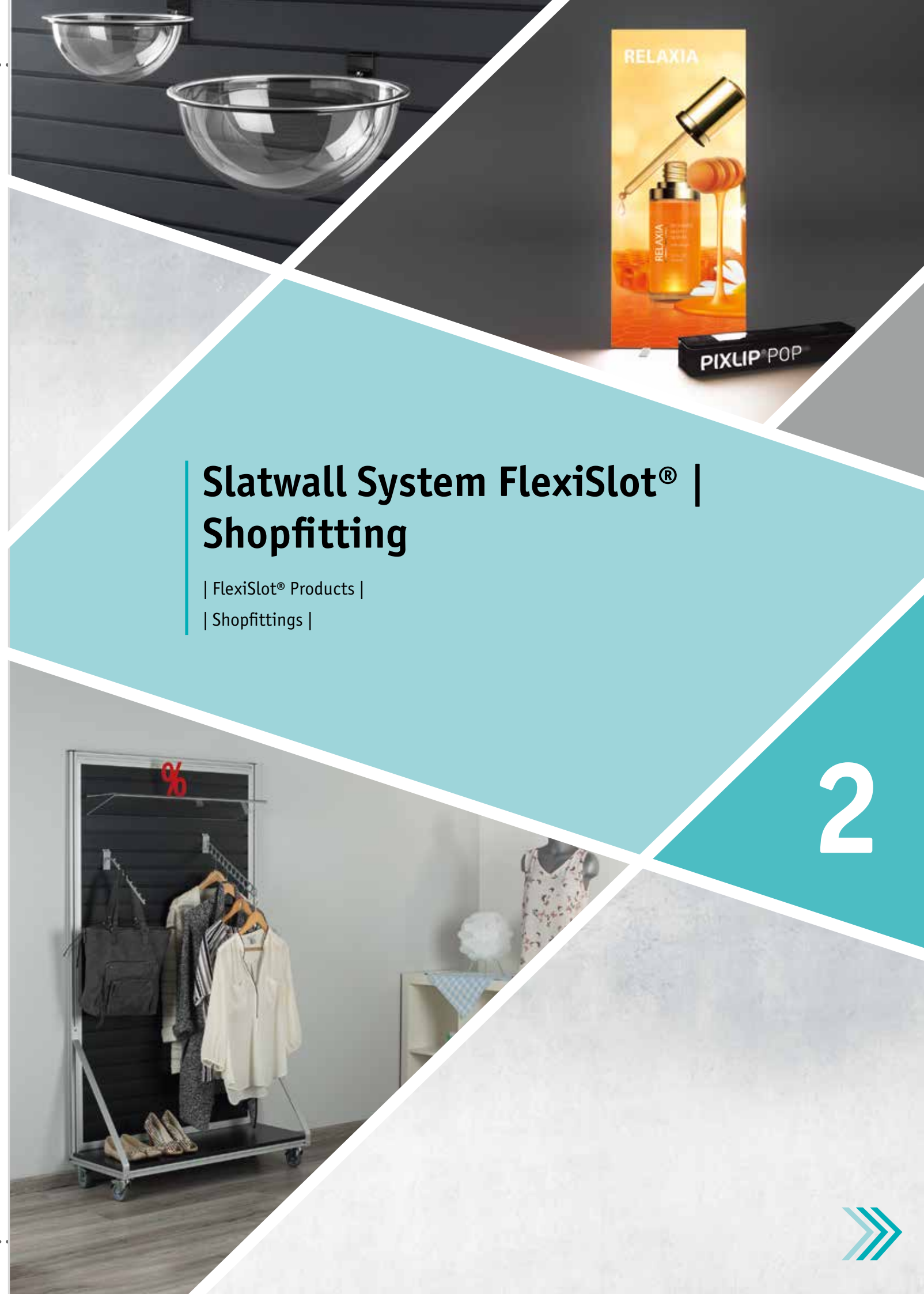

Slatwall System FlexiSlot® | Shopfitting

| FlexiSlot® Products |

| Shopfittings |



Floorstanding Displays

2



FlexiSlot® Tower "Slim"

Thanks to the narrow construction this double-sided slatwall display can show off your products using only a small footprint. The plastic FlexiSlot profile is covered on the sides with a silver anodised aluminium profile.

Version: 2-sided; FlexiSlot colour: magenta similar to RAL 3004; Width: 255 mm; Useable FlexiSlot width: 215 mm; Material of base: steel; Colour of base: silver similar to RAL 9006; Base diameter: 400 mm

Height: 1830 mm; Rotating fixture: no

51.0038.84

Height: 1840 mm; Rotating fixture: yes

51.0038.238

1. Also available with a black powder coated steel base!
2. Available in our online shop with marble base.
3. Available in many colours of profile: visit our online shop!

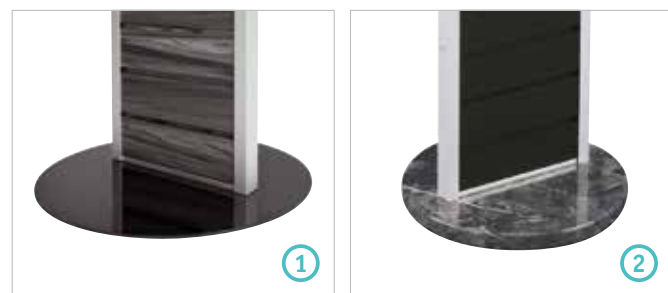

FlexiSlot® Tower "York"

With its 4-sided display option this plastic slatwall tower offers plenty of space. The silver anodised aluminium edges give the display an unobtrusive frame.

FlexiSlot colour: traffic white, similar to RAL 9016; Width: 276 mm; Depth: 276 mm; Material of base: steel; Colour of base: silver similar to RAL 9006; Base diameter: 400 mm

Height: 1820 mm; Rotating fixture: no

51.0037.281

Height: 1830 mm; Rotating fixture: yes

51.0037.296

1. Available in many colours of profile: visit our online shop!
2. Also available with black steel base.
3. With marble base and extension option with rotating component.
4. Underneath view: rotating component incl. scratch preventor.
5. Also available in our online shop as a pillar cover.
6. Also available in our online shop as a separable version for use on the move!

Ideal for displaying items at exhibitions or as an information column.

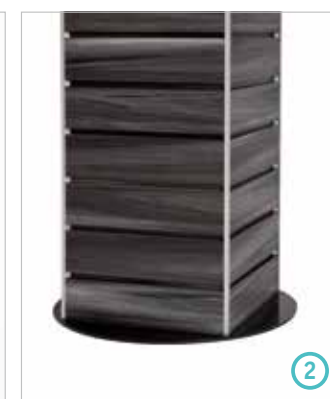
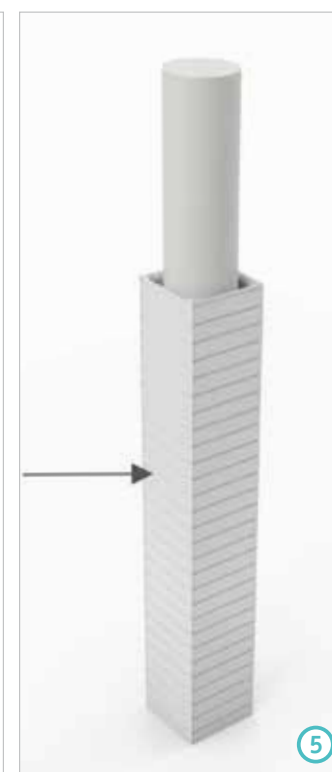

2

Aktuelle priser findes på vores Webshop

Større udvalg findes på : www.vkf-renzel.dk

Modular Components

2



FlexiSlot® Shelf System "Quattro"

An easy to assemble shelving system consisting of plastic FlexiSlot slatwall panels. Frame made from sturdy silver anodised aluminium "Quattro" profile. Base with 4 castors (ø 75 mm) and a white wooden panel attached. Several "Rack-Line" units can be combined by joining the "Quattro" profiles, and can be further enhanced using our range of "Quattro" accessories.

FlexiSlot colour: pure white similar to RAL 9010; Width: 1000 mm; Useable FlexiSlot width: 900 mm; Height: 1800 mm

for use on the wall

Depth: 400 mm
51.0152.6



for freestanding use

Depth: 500 mm
51.0152.7



Create your shop just as you want it!

Other items and visualisations can be found at www.vkf-renzel.dk. It is possible to fit the components with FlexiSlot profile on both sides or to print the back panel area.

1. Wall-mounted version
2. Available in many colours of profile: visit our online shop!
3. Version for freestanding use



Aktuelle priser findes på vores Webshop

Counter Top Display Stands

2

FlexiSlot® Table Display

This slatwall display offers the possibility to present items on counters or sales tables. Choose a colour suitable to your requirements! The FlexiSlot tile with silver anodised aluminium frame sets the scene for your products. A white wooden base provides the required stability.

Version: 1-sided; FlexiSlot colour: pure white similar to RAL 9010; Width: 300 mm; Height: 450 mm; Depth: 200 mm
51.0223.2

Display your products or goods using our versatile range of slatwall accessories.

1. Also available in our online shop as a 4-sided table-top tower "York Rotation"!
2. Available in many colours of profile: visit our online shop!



Slatwall Accessories



Slatwall Single Hook

Wire thickness: 4.8 mm; Surface: galvanised

- Length: 100 mm
58.0016.1
- Length: 150 mm
58.0016.2
- Length: 200 mm
58.0016.3
- Length: 250 mm
58.0016.4
- Length: 300 mm
58.0016.5



Slatwall Double Hook 100 - 400 mm

Wire thickness: 4.8 mm; Surface: galvanised

- Length: 100 mm
58.0017.1
- Length: 150 mm
58.0017.2
- Length: 200 mm
58.0017.3
- Length: 250 mm
58.0017.4
- Length: 300 mm
58.0017.5

Større udvalg findes på : www.vkf-renzel.dk

2



FlexiSlot® Glass Shelf

Material: steel / glass; Surface: powder coated;
 Colour: silver similar to RAL 9006;
 Shelf size: 710 x 300 mm (W x D);
 Features: incl. 4 suction cups
59.2887.1



Wall-Mounted Leaflet Holder "Perfect"

The curved shape prevents leaflets from flopping forward.
 Material: polystyrene; Colour: crystal clear; Size: A4;
 Orientation: portrait; Fill depth: 40 mm
67.0003.4

1. The matching hanger (65.0030.1) can be found in our online shop.



Display Hemisphere "Acanthus"

For slatwall; 2 parts; consists of a hemisphere and wire holder
 Diameter: 200 mm
65.0091.1
 Diameter: 300 mm
65.0091.2



FlexiSlot® Hanging Tray "Lotus"

Material: acrylic; Material thickness: 3 mm;
 Colour: crystal clear; Depth: 250 mm

Ideal for use with Tower "Slim".

- Width: 200 mm
60.0264.42
- Width: 250 mm
60.0264.43
- Width: 450 mm
60.0264.44

Other widths on request.

PIXLIP "POP"

PIXLIP POP is the first mobile advertising banner with backlighting and guaranteed success. As an alternative to the conventional Roll Up Banner PIXLIP POP is ideal for the use at the POS and in the event industry. Thanks to the integrated backlighting by highly efficient LED strips, the new banner display attracts all eyes. The average life expectancy of a PIXLIP POP illuminated frame is about 10 years. The printed advertising textile can be exchanged at any time at a reasonable price.

Material: aluminium; Profile colour: silver;
 Size: 850 x 2000 mm (W x H); Illumination: LED module;
 Version: one-sided; Features: with bag

Print: without print
10.0523.1
 Print: with print
10.0523.2



Poster and Product Display "Construct"

This display offers a combination of dump bin and promotional panel with aluminium click frame. The silver anodised surface of the frame profile is reflected in the Construct profiles of the lightweight yet strong framework. The sides are covered by white plastic panels and can be printed on request with your advertisement.

Frame material: aluminium / plastic;
 Profile type: square tube, 20 x 20 x 1.5 mm;
 Insert size: A2 (420 x 594 mm); Orientation: portrait;
 Width: 450 mm; Height: 1000 / 1625 mm;
 Depth: 450 mm; Fill height: 300 mm

Print / motif: without print

51.0227.2

Print / motif: to customer specification

51.0227.3





FloorWindo "FW 5"

The slim design is easy to accessorise;
New anti-slip coating for better grip; Material: plastic;
Outer size: 898 x 632 x 4 mm (W x H x D);
Colour: black / transparent; Insert size: A1
53.0038.8

Use only indoors and on flat, even surfaces.



DeskWindo "DW 5"

The slim design is easy to accessorise;
New anti-slip coating for better grip;
Material: plastic; Colour: black / transparent; Insert size: A3;
Width (outer): 437 mm; Height (outer): 317 mm;
Depth (outer): 3 mm

Outer dimensions: 437 x 317 x 3 mm (W x H x D).
53.0039.9

NEW



Shopping Basket made from recycled Material

With our shopping basket, you help to save raw materials and conserve resources sustainably. The plastic is made of 100% recycled PP without the use of crude oil, thus saving resources. Since the basket can also be completely recycled, the material cycle is closed.

Capacity: 20 l; Material: recyclate (Systalen Primus);
Width: 300 mm; Height: 225 mm; Length: 430 mm;
Number of handles: 1; Colour of handle: grey; Version: standard

- Colour: blue
68.0173.1
- Colour: grey
68.0173.2
- Colour: green
68.0173.3



Cash Dish "Isatis"

Includes 4 pads to protect your counter;
Material: acrylic; Colour: crystal clear;
Width: 175 mm; Depth: 210 mm
65.0049.1

Promotional printing on request.

Aktuelle priser findes på vores Webshop

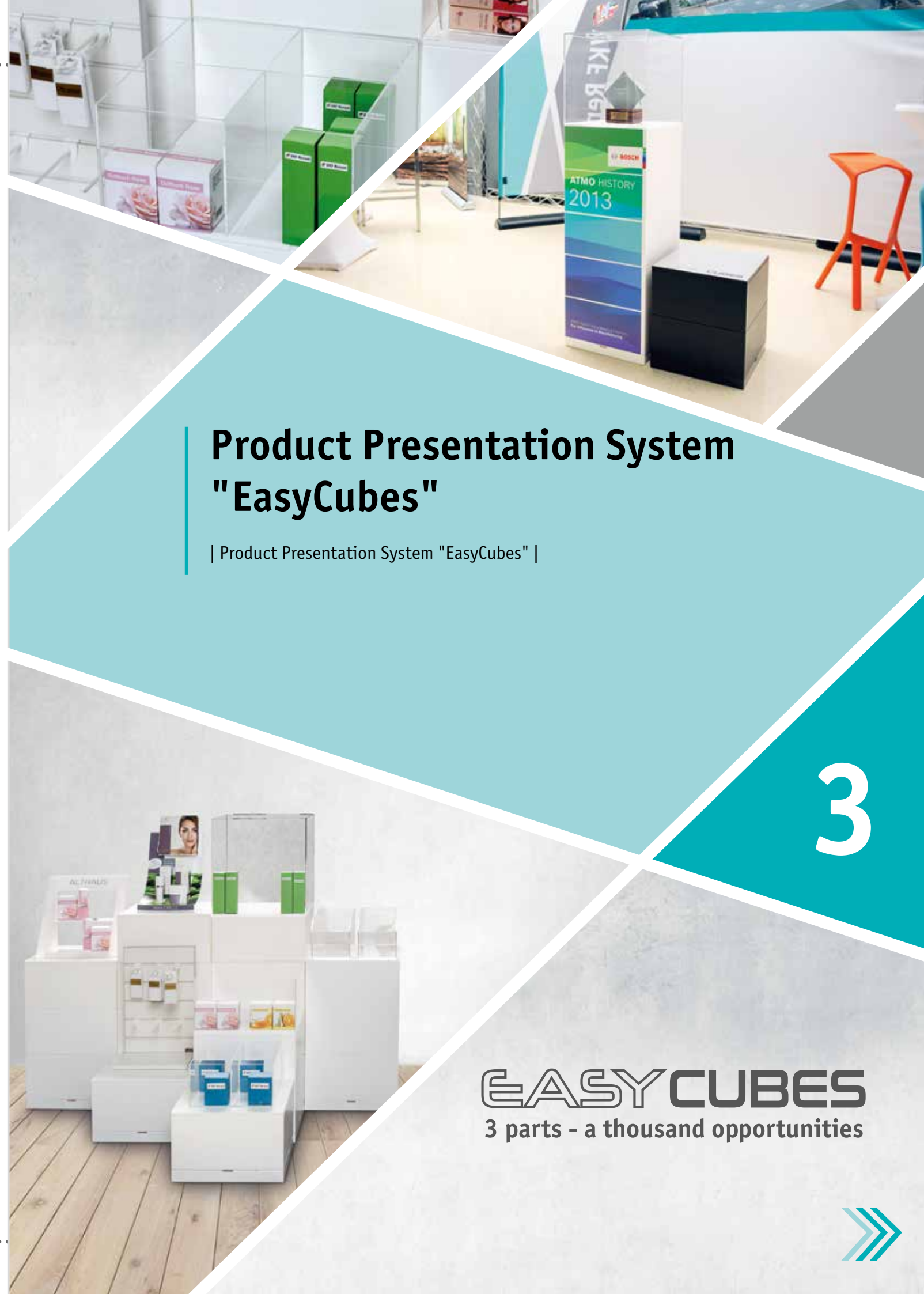

Product Presentation System "EasyCubes"

| Product Presentation System "EasyCubes" |

EASYCUBES
3 parts - a thousand opportunities



Quick and easy product presentation.

EasyCubes is a patented, modular slot together display system consisting of only three high-quality basic elements that can be easily varied and reconfigured without tools. The system revolutionises the conventional way of presenting products, which is usually static - you can redecorate within minutes, when and how you want.

3

EasyCubes "Floor"

Material: plastic High Impact Polystyrene;
Width: 400 mm; Height: 50 mm;
Depth: 400 mm; Weight: 1.0 kg;
Features: incl. 2 connectors;
Load capacity: up to max. 2000 kg
when used with a Cover unit

Colour: white, high gloss
80.1024.13
Colour: black, matt
80.1024.4

EasyCubes "Cube"

Material: plastic High Impact Polystyrene;
Width: 400 mm; Height: 200 mm;
Depth: 400 mm; Weight: 2.0 kg;
Print: without print;
Load capacity: up to max. 70 kg

Colour: white, matt
80.1024.2
Colour: black, matt
80.1024.3

EasyCubes "Cover"

Material: plastic High Impact Polystyrene;
Width: 400 mm; Height: 10 mm;
Depth: 400 mm; Weight: 0.5 kg;
Print: without print;
Load capacity: up to max. 2000 kg
when used with a Floor unit

Colour: white, high gloss
80.1024.1
Colour: black, matt
80.1024.6

EasyCubes "Cover" incl. digital print

Material: plastic High Impact Polystyrene;
Width: 400 mm; Height: 10 mm;
Depth: 400 mm; Weight: 0.5 kg;
Print: digital print - flatbed;
Load capacity: up to max. 2000 kg
when used with a Floor unit

Colour: white; Motif: cobblestone small
80.1024.7
Colour: white; Motif: pebbles
80.1024.8
Colour: white; Motif: dark wood
80.1024.9
Colour: white; Motif: grass
80.1024.10
Colour: white; Motif: light wood
80.1024.11
Colour: black; Motif: carbon
80.1024.12
Colour: white; Motif: "Sale"
80.1024.14
Colour: white; Motif: "Big Sale"
80.1024.15

Colour: white; Motif: customer defined,
background colour white
80.1024.16

Colour: black; Motif: customer defined,
background colour black
80.1024.17



Aktuelle priser findes på vores Webshop

Micro Suction Film incl. Print for EasyCubes "Cube"

The film can be printed to suit your requirements and allows you to advertise on all 4 sides of the cube. We fit the film and this service is included in the price.

Material: Micro Suction Sheet; Colour: white; Width: 1630 mm;
Height: 185 mm; Print method: 4 colour digital UV direct print,
one-sided; Print / motif: customised print; Outline: rectangular
14.0073.174

Dump Bin for EasyCubes

Use the EasyCubes for product sales with the help of the practical dump bin for EasyCubes.

Material: acrylic; Material thickness: 4 mm;
Colour: crystal clear; Width: 400 mm; Depth: 400 mm
Height: 200 mm
60.0248.41
Height: 400 mm
60.0248.42

Divider for Dump Bin EasyCubes

Material: acrylic; Material thickness: 4 mm; Colour: crystal clear

Version: for 200 mm high bin
60.0475.7
Version: for 400 mm high bin
60.0475.6



Større udvalg findes på : www.vkf-renzel.dk

3

3

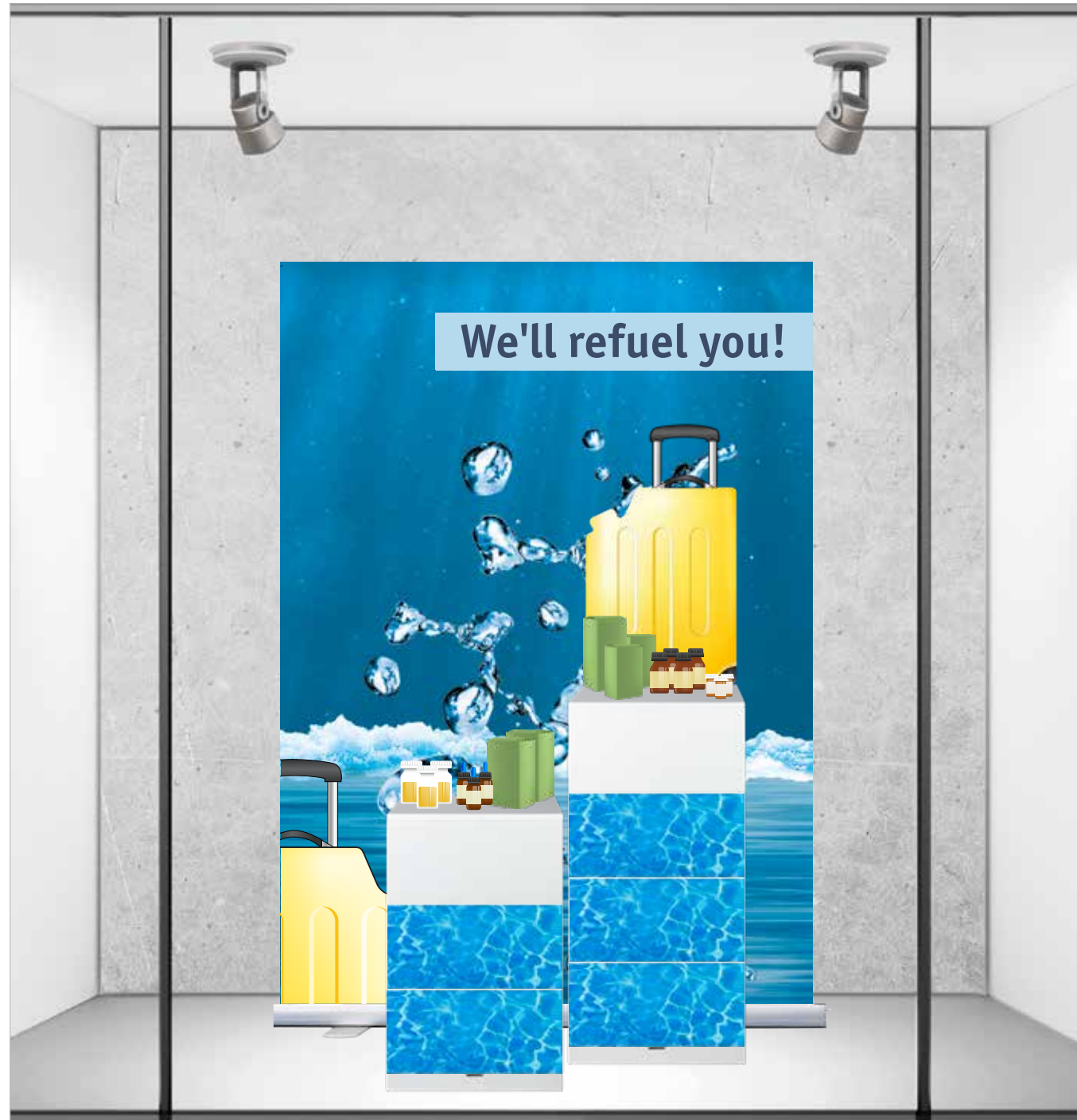

Display Window Concept 1 (80.0902.9)

- | | |
|---|--|
| <p>2x EasyCubes "Floor"
400 x 400 x 50 mm (W x D x H)
white (80.1024.13)</p> <p>7x EasyCubes "Cubes"
400 x 400 x 200 mm (W x D x H)
white, matt (80.1024.2)</p> <p>2x EasyCubes "Cover"
400 x 400 x 10 mm (W x D x H)
white, gloss (80.1024.1)</p> | <p>5x Microsuction Film for EasyCubes
incl. digital print (14.0073.175)</p> <p>1x Rollbanner "Simple"
1.500 x 2.000 mm (W x H)
(80.0835.5)</p> <p>1x Digitally Printed Banner for Rollbanner "Simple"
Frontlit - B1 certificated,
1.500 x 2.000 mm (W x H)
(80.0125.18)</p> |
|---|--|

Aktuelle priser findes på vores Webshop

3



Display Window Concept 2 (80.0902.10)

- | | |
|--|---|
| <p>3x EasyCubes "Floor"
400 x 400 x 50 mm (W x D x H)
white (80.1024.13)</p> <p>10x EasyCubes "Cubes"
400 x 400 x 200 mm (W x D x H)
white, matt (80.1024.2)</p> <p>3x EasyCubes "Cover"
400 x 400 x 10 mm (W x D x H)
white, gloss (80.1024.1)</p> | <p>1x Rollbanner "Stick"
850 x 2.000 mm (W x H)
(80.0126.1)</p> <p>1x Digitally Printed Banner for Rollbanner "Stick"
850 x 2.000 mm (W x H)
Frontlit (80.0131.1)</p> |
|--|---|

Større udvalg findes på : www.vkf-renzel.dk

3



Display Window Concept 4 (80.0902.12)

- | | |
|---|---|
| 3x EasyCubes "Floor"
400 x 400 x 50 mm (W x D x H)
black (80.1024.4) | 1x Insert Frame "Multi"
DIN A1 (594 x 841 mm),
insert of narrow side, without fixings
(50.0046.1) |
| EasyCubes "Cubes"
400 x 400 x 200 mm (W x D x H) | 2x Hanging Eyelet for Poster Frames
Eyelet parallel to frame, A3-A6
(53.0019.4) |
| 2x black, matt (80.1024.3) | |
| 3x white, matt (80.1024.2) | |
| EasyCubes "Cover"
400 x 400 x 10 mm (W x D x H) | 1m ² Print on Photo Paper
Material: 135 g/m ² , gloss
(14.0069.46) |
| 2x black, matt (80.1024.6) | |
| 1x white, gloss (80.1024.1) | |

Aktuelle priser findes på vores Webshop

3



Display Window Concept 5 (80.0902.13)

You can bring an elegant presentation of your offer into your shop window with Set 5. You display your goods in a high quality and effective way on black and white EasyCube columns at the eye level of your customers. The puristic basic elements put your product presentation in the foreground. The black and white design of the presentation column breaks up the display and acts as an eye-catcher for passers-by. Let us know your specifications. Captivate the passing public!

- | | |
|--|---|
| 2x EasyCubes "Floor"
400 x 400 x 50 mm (W x D x H)
black (80.1024.4) | 1x Back Wall Pop-Up System "Stretch"
incl. double-sided digitally printed banner
1.520 x 340 x 2.250 mm (W x D x H)
(80.1052) |
| EasyCubes "Cubes"
400 x 400 x 200 mm (W x D x H) | |
| 5x black, matt (80.1024.3) | |
| 3x white, matt (80.1024.2) | |
| 2x EasyCubes "Cover"
400 x 400 x 10 mm (W x D x H)
white, gloss (80.1024.1) | |

Større udvalg findes på : www.vkf-renzel.dk

Examples of use

3



Aktuelle priser findes på vores Webshop



Price Labelling | Shelf Optimisation

| Self Adhesive Data Strips | Shelf Divider Systems | Stock Pushers |
| Shelf Optimisation | Accessories | Fixings for Electronic Price Labelling |

4



Self Adhesive Data Strips

4



"GLS" Shelf Edge Strip

For 5-10 mm thick glass and wooden shelves; Colour: transparent or white "GLS 39"

Holds 39 mm high ticket
20.0116.



"DBR" Shelf Edge Strip

Fitted with adhesive tape and dust cover; Colour: transparent or white "DBR 39"

Holds 39 mm high ticket
20.0007.

- We can cut profiles to size for you.
- Also available with magnetic tape! Please ask for a quote!



"TE" Shelf Edge Strip

For Tegometal shelves; Colour: transparent or white "TE 39"

Holds 39 mm high ticket
20.0041.

Coloured profiles on request.

Aktuelle priser findes på vores Webshop

Scanner Profile "HEP 39"

Holds 39 mm high ticket, with ridge for dividers. Sticks to all metal wooden or glass shelving. Colour: transparent or white

Holds 39 mm high ticket
22.0006.



4

"GLSP 26" Shelf Edge Strip

For 26 mm high tickets; With ridge for dividers; For 5-10 mm thick glass and wooden shelves; Colour: transparent and white **22.0009.**



Divider Profile "PEK"

Anchor profile for dividers; Without shelf edge profile; Available with adhesive or magnetic tape; Colour: transparent and white **22.0012.**

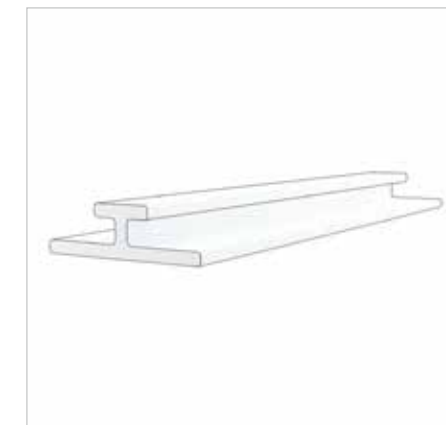

Divider Profile "PEK 25"

Anchor profile for dividers; Without shelf edge profile; Incl. attachment to hook on "MP" range dividers; Available with adhesive or magnetic tape; Colour: transparent;

Bracket width 25 mm
22.0144.



Større udvalg findes på : www.vkf-renzel.dk

Shelf Divider Systems

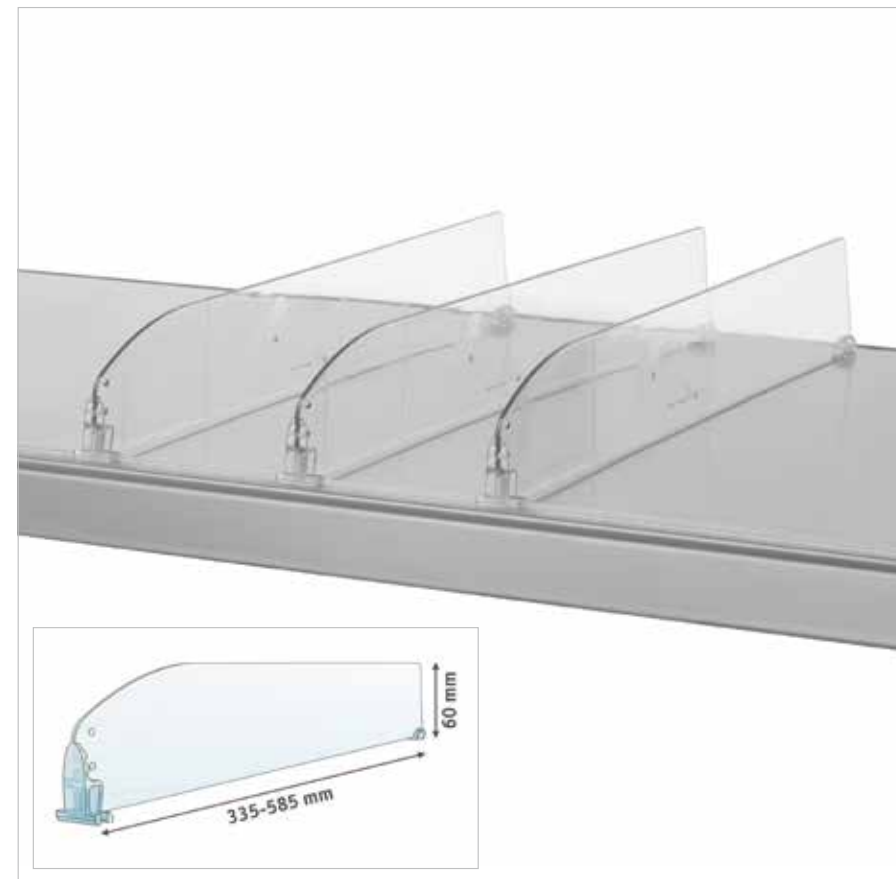
**Shelf Divider**

Without stopper, with clip at back;

Material: PET; Colour: transparent;
Height: 60 mm

Length: 310 mm

22.0152.6

Length: 335 mm

22.0152.7

Length: 360 mm

22.0152.8

Length: 385 mm

22.0152.9

Length: 400 mm

22.0152.10

Length: 435 mm

22.0152.12

Length: 460 mm

22.0152.13

Length: 485 mm

22.0152.14

Length: 585 mm

22.0152.19

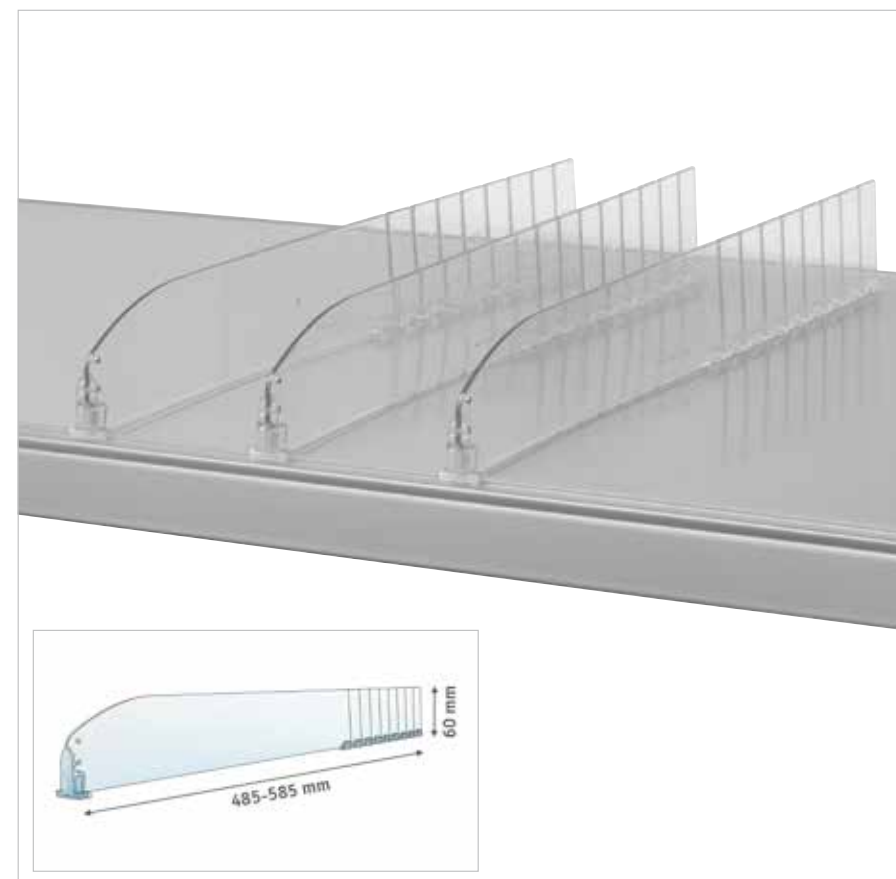
**Shelf Divider**

Without stopper; for various shelf depths;
with 8 break points;

Material: PET; Colour: transparent;
Height: 60 mm

Length: 485 mm; Version: break point
every 25 mm from 285 mm

22.0195.1

Length: 585 mm; Version: break point
every 25 mm from 385 mm

22.0195.2

Aktuelle priser findes på vores Webshop

Stock Pushers

Stock Pusher "Push VI" Wide with Stopper 90 °

With progressive spring strength; for all shelf depths;
with extra high stopper; pusher size: 40 x 72 mm (W x H);
adapter size: 60 x 75 mm (W x H);
spring strength: 2N, 4N, 6N, 10N or 14N
22.0175.

**Stock Pusher Push VI "Narrow"**

With constant spring strength; for all shelf types;
with full-height stopper; pusher size: 27 x 72 mm (W x H);
Adapter size: 28 x 36 mm (W x H);
Spring strength: 2N, 4N, 6N, 10N or 14N
22.0257.

**Stock Pusher "Push VII"**

With constant spring strength;
Particularly suited to small or narrow products;
Available for all shelf depths; With half-height stopper;
Pusher size: 18 x 60 mm (W x H); Adapter size: 17 x 36 mm (W x H);
Spring strengths: 2N, 4N, 6N, 10N or 14 N
22.0296.



Større udvalg findes på : www.vkf-renzel.dk

Shelf Optimisation

NEW

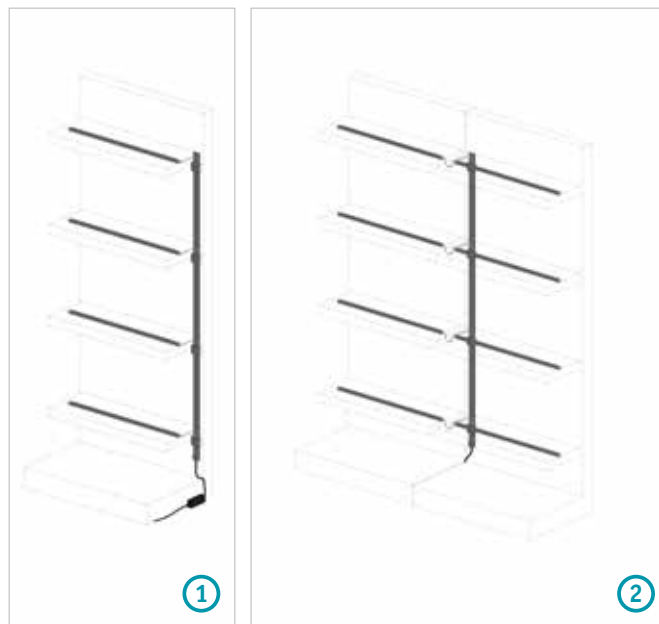
**Shelf Lighting System "FlexiPower"**

Simple and effective: that's our new, flexible lighting set for your shelves! Highlight your perfume range in the chemist or put new items in the right light for the Christmas season. Combine several rails again and again or set your highlights with only one LED rail. A clever magnet system allows you to attach the LED rails in front of or behind your metal shelf in just a few simple steps. The LED strips are powered via small magnetic collectors, each with 2 connection options. These are attached by spring-loaded contacts to a power rail which is mounted vertically. If necessary, you can simply shorten the power rail yourself on site to the correct height of your shelves. The small collectors can be moved along the distribution rail without interrupting the power supply.

Up to 3 LED strips can be connected in a row via a magnetic collector and a maximum of 8 LED strips can be used via a power rail. For maximum flexibility, each LED bar has 2 connection options. Start your lighting project!

Shelf lighting set "Mini" consists of:

- 1x power rail (10.0512.15)
- 1x power supply unit (10.0086.126)
- 4x LED strips 950 mm each (10.0231.363)
- 4x magnetic clips (10.0512.14)
- 4x distribution box (10.0512.16)
- 4x connecting cable 600 mm (10.0512.26)

Fixing: magnetic; Connection: 230 V;
Voltage [V]: 24 V; Light technology: LED

Designed for: 1 gondola;
Number of lamps: 4x LED strips 950 mm;
Power input [W]: 38 W; Version: mini

10.0526.1

Designed for: 2 shelf sections;
Number of lamps: 8x LED strips 950 mm;
Power input [W]: 76 W; Version: midi

10.0526.2

1. Version Mini: 10.0526.1.

2. Version Midi: 10.0526.2.

"Gondola Flag" U-Shaped Insert Frame

- ideal for labelling metal shelves
- secure fastening with 2 magnets \varnothing 50 mm
- insert for signs and boards up to a material thickness of 5 mm (not included)
- made in custom sizes from 20 pieces
- RAL colours from 1 piece
- board made of PVC foam, unprinted or digitally printed, available for 1+ pieces

Frame material: aluminium; Frame colour: silver anodised;
Inner frame size: 700 x 120 mm (W x H);
Fixing: 2 silver magnets \varnothing 50 mm;
Designed for: signs and boards up to 5 mm thick

50.0268.1

1. Pictured with accessories: board in PVC foam 700 x 150 mm

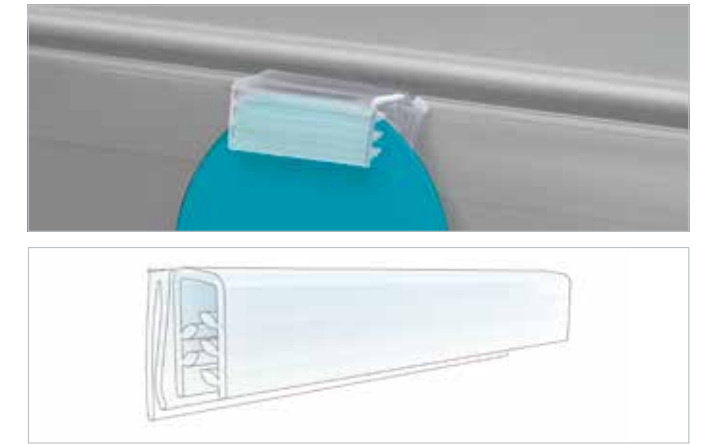

Accessories

**Pegwall Hook Accessory "Stock Aid"**

Self-adhesive; adhesive pad measuring 50 x 27 mm (W x H);
Load capacity of up to 500 g;

Material: PET; Colour: transparent; Width: 50 mm;
Height: 50 mm; Width of adhesive area: 50 mm;
Height of adhesive area: 27 mm; Contains: 1000 per box
24.0109.1

The adhesive "Stock Aid" hooks enable otherwise non-hanging goods to be displayed on pegwall hooks.

**Swinging Price Clip for Pegboard Hooks**

Width: 26 mm; Colour: white

Wire thickness: 4.8 mm; Height: 26 mm

24.0106.1

Wire thickness: 4.8 mm; Height: 42 mm

24.0106.2

Wire thickness: 6 mm; Height: 42 mm

24.0106.6

Wire thickness: 8 mm; Height: 42 mm

24.0106.7

Sign Gripper

To attach over shelf edge strips; with hinge; without sign;

Colour: transparent; Application: for material up to 2 mm thick

Minimum order quantity 100 pieces

Length: 25 mm

24.0165.2

Minimum order quantity 100 pieces

Length: 75 mm

24.0165.1

**Price Ticket Holders for Glass Shelves**

The insert pocket of the price tag holder is made of 2 mm clear acrylic. This elegant material ensures a high quality look. The glass holder mounted on the back has a slight angle and thus creates the ideal reading angle. Use the label holder in pharmacies and markets to inform your customers about product details directly on the glass shelf. The price tag holder can be easily attached to glass shelves with a thickness of 5-10 mm and removed again if required.

You can also change the labels as desired. In A7 size (width 105 mm, height 74 mm) for flexible placement.

Application: for clipping onto 5 - 10 mm thick shelving

60.0339.257

Aktuelle priser findes på vores Webshop

Større udvalg findes på : www.vkf-renzel.dk

Fixings for Electronic Price Labelling

We are constantly developing new profiles and fixing options for all common ESL systems. We stock ESL profile types suitable for labels from: tronITAG, Displaydata, Findbox, SES-Labels / iMAGOTAG, Pricer, Samsung, Hanshow

4



Exchangeable Cover, various colours

28.0236.

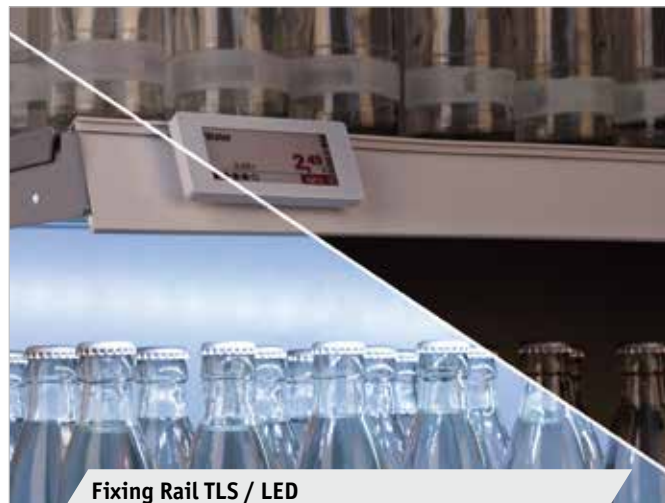

Fixing Rail TLS / LED for tronITAG

28.0341.



Fixing Rail Wanzl / Wire-Tech for Displaydata and SES Vision

20.1796.



ESL Display in PET

63.0164.



Basket Clip

28.0412.1

Product Holders | Frames | Advertising Stands | Digital Signage

| Product Holders | Frames |

| Advertising Stands | Digital Signage |

5

WEB-SERVICE



Our complete range of electronic price rails & accessories can be found at:

www.esl-fittings.com



Product Display Stands

5

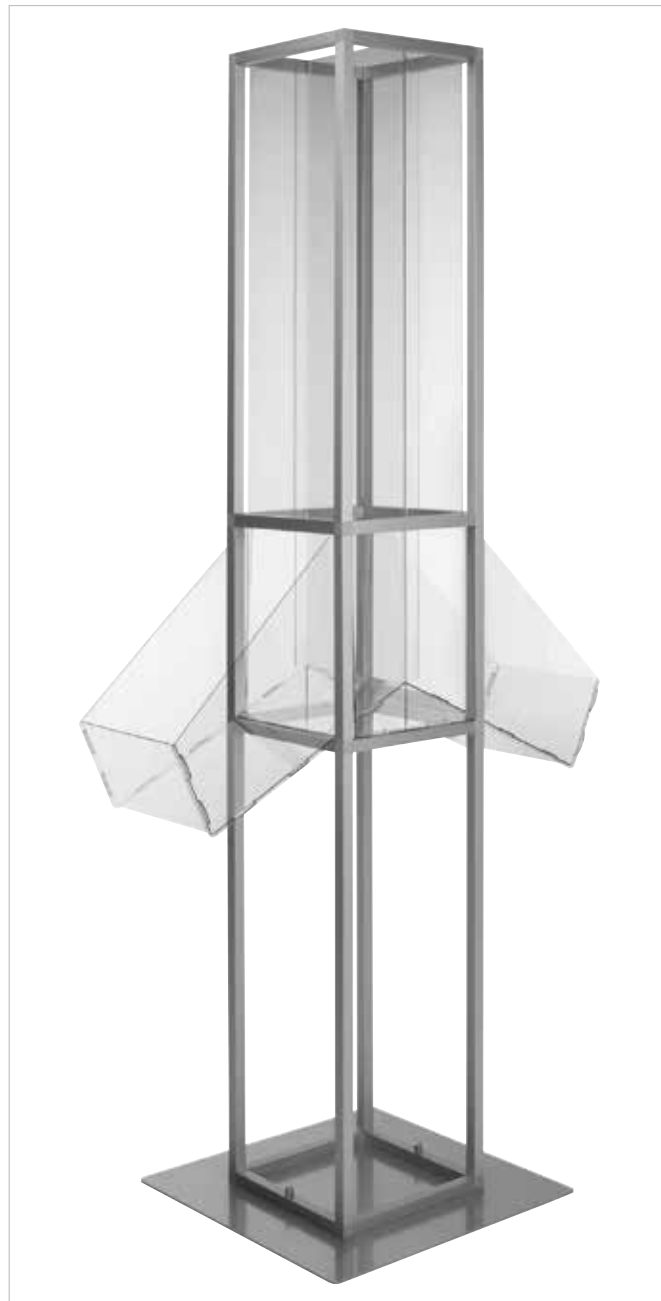

Product Display "Construct"

This display can be filled on both sides. The divided inserts mean the bins can be filled with different products.

Frame material: aluminium / plastic;
 Profile type: square tube, 20 x 20 x 1.5 mm;
 Colour of frame: silver anodised / grey;
 Shelf material: PET; Colour of shelf: transparent;
 Shelf size: 242 x 1159 x 877 mm (W x H x D);
 Material of base: steel;
 Colour of base: silver similar to RAL 9006;
 Size of base: 500 x 500 mm; Height: 1770 mm;
 Total depth: 877 mm

51.0163.4



A-Shaped Shelf "Construct"

Versatile presentation shelf; The framework in silver anodised aluminium profile as well as the grey plastic corner connectors can be collapsed for transport. The round tubing attached to the frame holds 3 clear PET shelves. The unit is locked in place by positioning the shelves in the A-frame.

Profile type: square tube, 25 x 25 x 1.5 mm;
 Shelf size: 445 x 195 mm / 445 x 330 mm / 445 x 465 mm (W x D);
 Total width: 500 mm; Total height (assembled): 1100 mm;
 Total depth: 700 mm

51.0167.13

1. Delivered unassembled.

Aktuelle priser findes på vores Webshop

5



Wall-Mounted Leaflet & Magazine Rack "Fidel"

In high quality stainless steel; Versatile for lots of different sized leaflets: A4, A5 and 1/3 A4; The leaflets are held in place by an acrylic sheet; The transparent area offers space for customised lettering; "Info" sticker is included;

Width: 300 mm; Height: 1400 mm; Depth: 110 mm;
 Fill depth: 20 mm; Number of dispensers: 7

54.0002.2



Leaflet Stand "Size"

For 7 A4 portrait leaflets or 14 1/3 A4 portrait leaflets when using dividers; The large area on the lower part of the stand can be used for your customised lettering;

Material: steel; Surface: powder coated;
 Colour: aluminium silver; Width: 320 mm;
 Height: 1320 mm; Depth: 340 mm; Fill depth: 26 mm

54.0007.1

Individual lettering available on request.

Større udvalg findes på : www.vkf-renzel.dk

5



Leaflet Stand "Tondo NG"

The curved polystyrene leaflet dispensers allow even single leaflets to be displayed. The metal frame is powder coated in silver (RAL 9006).

Dispenser material: polystyrene; Orientation: portrait;
Base diameter: 320 mm; Total height: 1550 mm;
Fill depth: approx. 35 mm

Dispenser size: A4; Number of dispensers: 6

54.0067.5

Dispenser size: A5; Number of dispensers: 8

54.0067.8

Dispenser size: 1/3 A4; Number of dispensers: 8

54.0067.11



"Tondo" with Acrylic Hemisphere

In silver round tubing; The heavy black-grey marble base measuring \varnothing 350 mm guarantees a firm footing; Incl. acrylic dump bins \varnothing 300 mm and the corresponding black wire holders;

Height: 1500 mm

Number of acrylic hemispheres: 3

57.0012.1

Number of acrylic hemispheres: 4

57.0012.2

Aktuelle priser findes på vores Webshop

5

Counter Showcase "Syringa"

Lockable;

Material: acrylic; Colour: crystal clear

Includes adjustable shelf, removeable;
Material thickness: 4 mm; Width: 200 mm;
Height: 300 mm; Depth: 200 mm

60.0297.1

Includes adjustable shelf, removeable;
Material thickness: 5 mm; Width: 300 mm;
Height: 500 mm; Depth: 300 mm

60.0297.2



3-Tier Display

Set consisting of 3 U-shaped displays 100 x 100 x 100 mm, 150 x 150 x 150 mm and 200 x 200 x 200 mm (W x H x D);

Material: acrylic; Material thickness: 4 mm; Colour: crystal clear

60.0140.1



Shelving Display "Nigella"

Ideal for the till area. Position your products on 3 levels. The display is delivered unassembled. Space saving for shipping and storage. Easy to assemble with detailed instructions.

Material: acrylic; Colour: crystal clear; Material thickness: 4 mm;
Width: 330 mm; Height: 261mm; Depth: 157 mm

60.0350.13

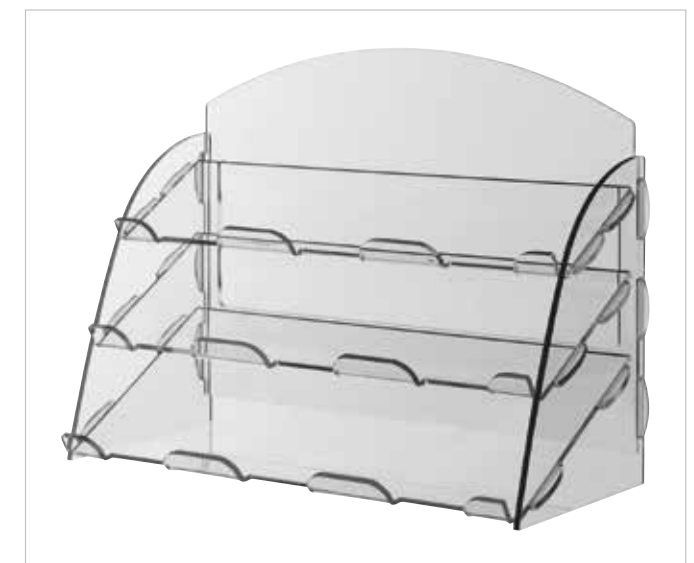

Større udvalg findes på : www.vkf-renzel.dk

NEW

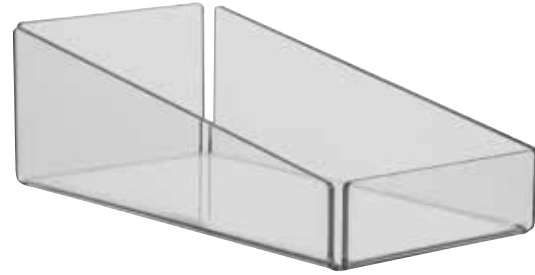

Product Box "Pieris"

Material: acrylic; Material thickness: 4 mm;
 Colour: crystal clear; Width (outer): 160 mm;
 Height at front: 50 mm; Height at rear: 100 mm;
 Depth (outer): 300 mm
60.0485.1

NEW

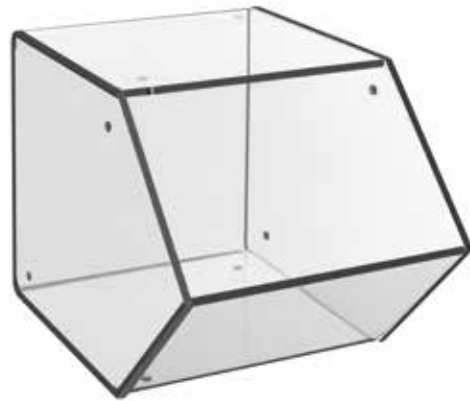

Dump Bin "Magnetica"

The bin is fitted with small magnets and can be positioned next to or on top of another. Ideal for giveaways and small items.

Material: acrylic; Material thickness: 3 mm;
 Colour: crystal clear; Width: 120 mm; Height at rear: 120 mm;
 Height at front: 60 mm; Depth: 180 mm
60.0786.1

1. Example of use with 8 dump bins.



NEW



Product Box "Majus" with Dividers

Material: acrylic; Material thickness: 4 mm;
 Colour: crystal clear; Width (outer): 300 mm;
 Height (outer): 150 mm; Depth (outer): 300 mm;
 Number of dispensers: 4
60.0344.128

1. Example with dividers removed.

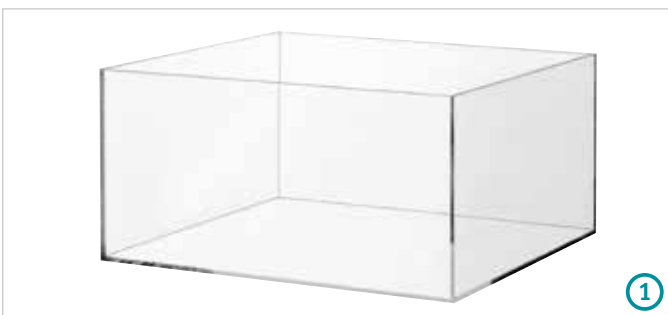

Plastic dump bin

Material: polystyrene; Colour: crystal clear

Plastic Dump Bin Small

Width: 136 mm; Height: 180 mm;
 Depth: 115 mm
65.0044.2

Large Plastic Dump Bin

Width: 170 mm; Height: 210 mm;
 Depth: 118 mm
65.0044.3

1. Small plastic dump bin
2. Large plastic dump bin.

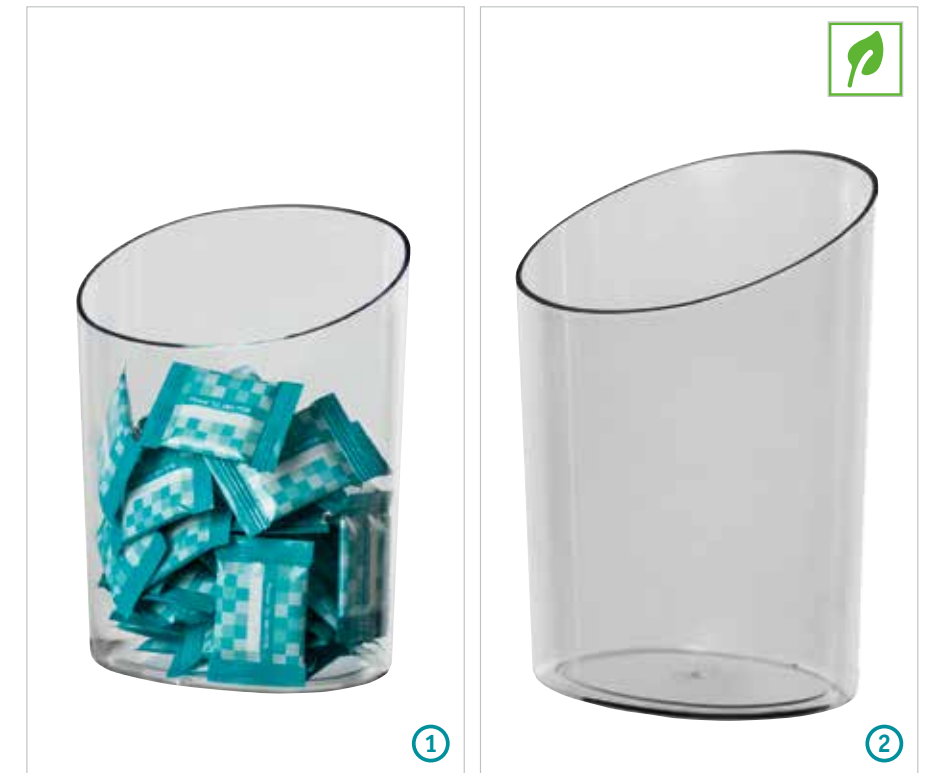

Display Sphere "Samolus"

Consists of 2 hemispheres; Diameter of opening: 112 mm;
 Material: polystyrene; Colour: crystal clear;
 Diameter: 200 mm; Features: with card holder
65.0046.1

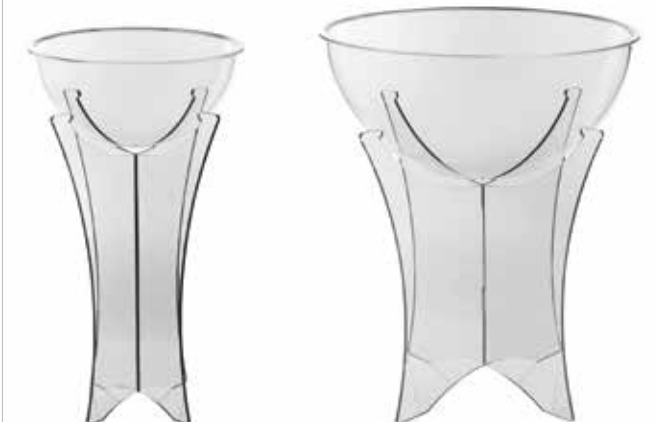

Hemisphere incl. Slot Together Base

2-part; Total height: 750 mm (hemisphere + base);
 Material: acrylic; Material thickness: 6 mm;
 Colour: crystal clear; Diameter: 600 mm
65.0176.15

Aktuelle priser findes på vores Webshop

Større udvalg findes på : www.vkf-renzel.dk

Advertising Displays / Frames

5



Single Table-Top Dispenser "Universum"

Material: polystyrene; Colour: crystal clear;
Orientation: portrait; Fill depth: 32 mm

Size: A4

67.0005.1

Size: A5

67.0005.2

Size: 1/3 A4

67.0005.3

1. From left to right: 67.0005.3, 67.0005.2, 67.0005.1.

Printing available on request.

1



2-Section Table-Top Stand "Universum"

Material: polystyrene; Colour: crystal clear; Size: A4;
Orientation: portrait; Fill depth: 32 mm

67.0030.14

1. A4.

2. A5

1

2

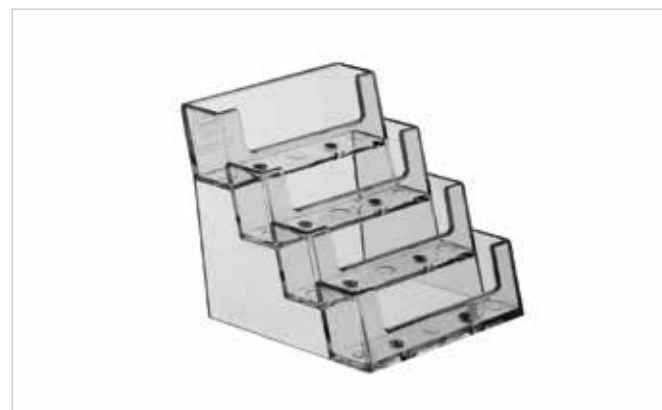

4-Tier Business Card Holder "Universum"

Material: polystyrene; Colour: crystal clear;
Width (inside): 90 mm; Total height: 50 mm; Fill depth: 17 mm

67.0057.1

Aktuelle priser findes på vores Webshop

5



Single Pocket Leaflet Holder "Perfect"

Material: polystyrene; Colour: crystal clear; Orientation: portrait

Size: A4; Fill depth: 40 mm

67.0003.1

Size: A5; Fill depth: 30mm

67.0003.2

Size: 1/3 A4; Fill depth: 30mm

67.0003.3

1. From left to right: 67.0003.1, 67.0003.2, 67.0003.3.

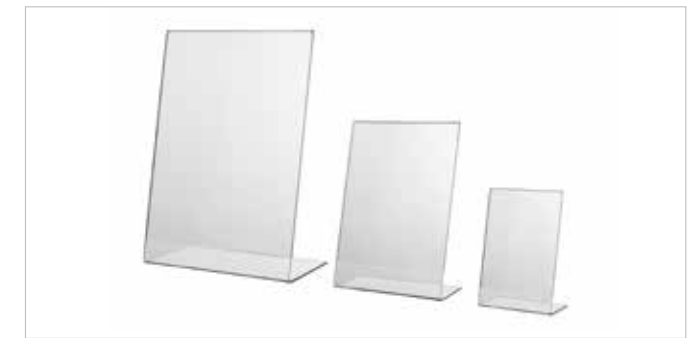

L-Display "Classic"

Due to its transparent material, the acrylic L-display "Classic" is ideal for presenting product and price information without distracting from your advertising message. Due to its slight angle, the acrylic L-display is particularly suitable for presentation in shop windows, on your trade fair stand or on tables and counters. The paper insert is simply slid between the double-sided acrylic.

Material: acrylic; Material thickness: 2 mm;
Colour: crystal clear; Size: A4

Orientation: portrait

60.0010.3

Orientation: landscape

60.0010.4

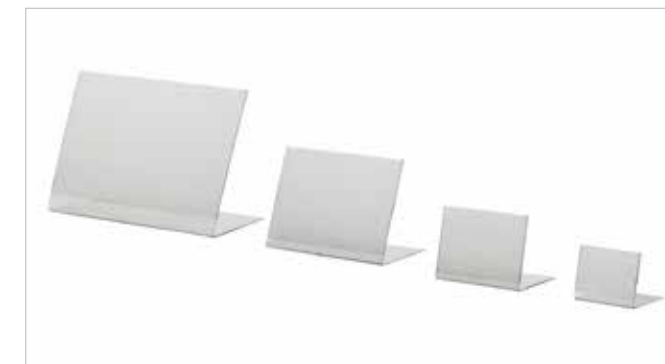

L-Display

Material: rigid PVC; Material thickness: 0.5 mm;
Colour: crystal clear; Insert size: A6;

Orientation: landscape; Angle: 75°

26.0008.9

Manufactured from UV-stabilised PVC.



Price Holder "Water-Gate"

This L-shaped stand is a fashionable alternative to the much used acrylic L-display, with a glossy chrome clamp to hold the price card at the top. With clamp;

Material: acrylic; Material thickness: 2 mm; Colour: crystal clear

Width: 110 mm; Height: 210 mm

60.0145.1

Width: 150 mm; Height: 280 mm

60.0145.2

Større udvalg findes på : www.vkf-renzel.dk

5



Pavement Sign, 32 mm profile, double-sided, with rounded corners, silver anodised

- Weather resistant, galvanised metal back panels and anti-reflective, UV-stabilised cover sheets
- Frame and base silver anodised
- Accessories such as header boards or wire hanging baskets are available as optional extras
- Custom finishes for 1+ pieces
- RAL powder coated upper profile and / or frame for 1+ pieces

Version: 2-sided; Orientation: portrait

Insert size: A0 (841 x 1189 mm); Total height: 1400 mm

50.0059.5

Insert size: A1 (594 x 841 mm); Total height: 1200 mm

50.0059.1

Insert size: A2 (420 x 594 mm); Total height: 900 mm

50.0059.2

Insert size: 700 x 1000 mm; Total height: 1140 mm

50.0059.4



Info Display "Curved", 25 mm Profile, silver anodised

- Optimum readin angle
- With click frame for A4 or A3 posters
- Mitred or rounded corners
- Can be used in portrait or landscape format
- Upright can be mounted convex or concave
- Frame incl. polystyrene back panel and anti-reflective, UV-stabilised cover sheet
- Silver anodised aluminium upright and silver powder coated steel base
- RAL powder coated for 1+ pieces
- Custom finishes for 1+ pieces

Size of base: 245 x 320 mm (W x H); Total height: approx. 1100 mm

Type of corner: mitred; Insert size: A3 (297 x 420 mm)

50.0256.1

Type of corner: mitred; Insert size: A4 (210 x 297 mm)

50.0256.2

Type of corner: rounded; Colour of corners: chrome plated; Insert size: A3 (297 x 420 mm)

50.0256.3

Type of corner: rounded; Colour of corners: chrome plated; Insert size: A4 (210 x 297 mm)

50.0256.4

1. Detailed view of mitred corner

2. Detailed view of rounded corner

Aktuelle priser findes på vores Webshop

5

Click Frame, 25 mm profile, with mitred corners, silver anodised

- Weather resistant polystyrene back panel and anti-reflective, UV-stabilised cover sheet
- With holes in lower profile to screw or hang in place
- Custom sizes for 1+ pieces
- RAL powder coated for 1+ pieces
- Minimum frame size: A6
- Maximum frame size: 1000 x 1400 mm

Frame material: aluminium;

Insert size: A4 (210 x 297 mm); Version: 1-sided

50.0003.4



Clamp Profile "Unico"

Base in silver anodised aluminium; Without promotional panel; Incl. anti-slip rubber; Holds panels 4-18 mm thick; Easy to secure panels using the star-shaped handle on the underneath;

Height: 120 mm; Depth: 430 mm

Clamp width: 100 mm

50.0162.1

Clamp width: 150 mm

50.0162.2

Clamp width: 200 mm

50.0162.3

Clamp width: 300 mm

50.0162.5

Clamp width: 400 mm

50.0162.6

Clamp width: 500 mm

50.0162.7

Clamp width: 600 mm

50.0162.8

1. Pictured including accessories:

- aluminium composite panel

- leaflet holder



Also available in special sizes for orders of just 1 piece!

Større udvalg findes på : www.vkf-renzel.dk



Showcard Stand "Series XT New"

With a transparent acrylic pocket; 149 mm long t-piece; Chrome plated telescopic pole; Metal base ø 160 mm; Colour of base: silver / transparent; Pole length: 320-620 mm; Orientation: portrait

Insert size: A3
53.0119.2
Insert size: A4
53.0119.1

- Acrylic pockets in special sizes on request.
- Ideal even for A3 format.



Showroom Display "Z"

Material: acrylic; Material thickness: 6 mm; Colour: crystal clear; Insert size: A4; Orientation: portrait; Height: 800 mm
60.0026.1

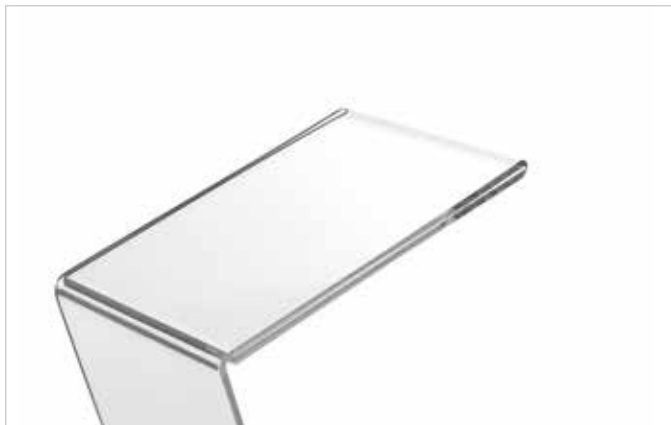

Aktuelle priser findes på vores Webshop

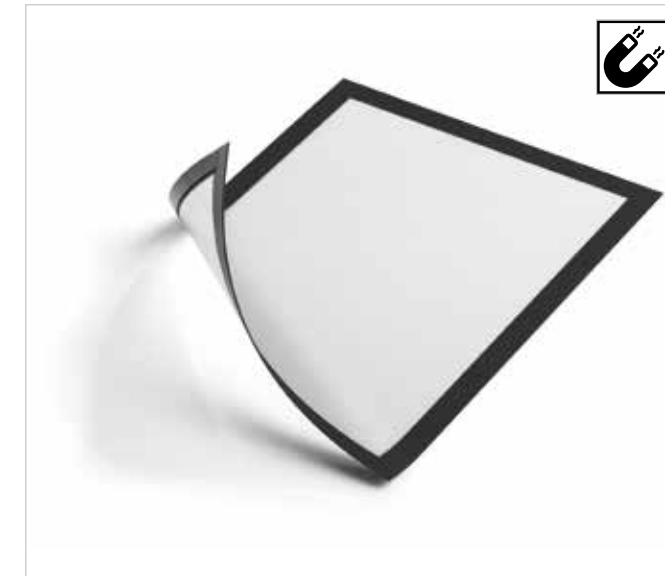

Info Pocket

This magnetic info pocket allows for easy, lightning-fast insert changes. It adheres to all ferrous metal surfaces and can be used in portrait or landscape format. It retains its extra strong adhesive force in a temperature range from -25°C to +60°C. Available in sizes A6 to A1 and in 12 different colours.

Material: PET; Frame colour: black; Insert size: A4; Fill depth: 3 mm; Fixing: with magnetic tape surround; Pieces per pack: 5 pieces
12.0098.23

Acrylic Pocket "Basic"

Available in portrait or landscape format; Material: acrylic; Material thickness: 2 mm; Colour: crystal clear; Insert size: A4

Orientation: portrait
60.0008.13
Orientation: landscape
60.0008.14

1. With holes
2. Without holes

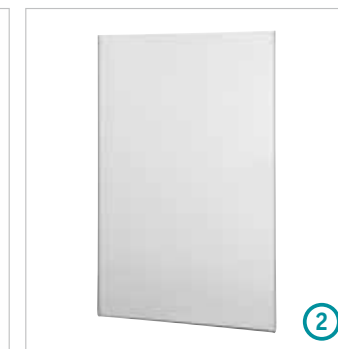

Window Poster Holder

Clings to glass without adhesive. To apply the pocket, simply rub it against the glass. Lifts off easily without leaving a residue. Extremely durable (heat resistant to 120°C).

Insert size: A1; Orientation: portrait / landscape; Width (outer): 645 mm; Height (outer): 890 mm
26.0026.1

Adhesion without glue!

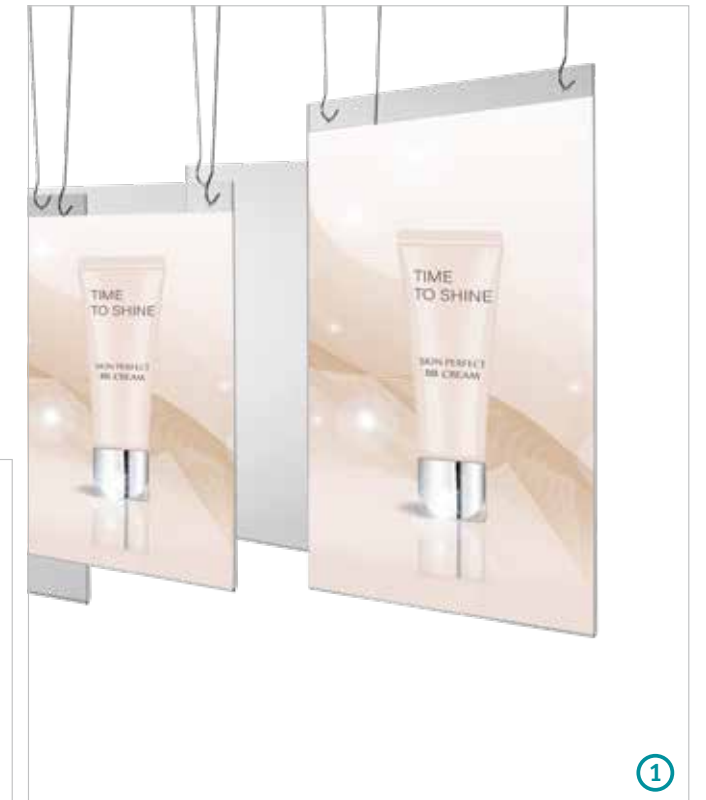

Større udvalg findes på : www.vkf-renzel.dk

5



Poster Pocket with Punched Holes
 Material: rigid PVC; Material thickness: 0.4 mm;
 Colour: anti-reflective; Insert size: A2;
 Orientation: portrait; Diameter: 6 mm; Number of holes: 2
26.0006.1

1. Poster pocket without metal eyelets.



1

All other insert sizes can be found in our online shop!



Double Hooks 60 - 2000 mm

The inexpensive double hooks made of wire are used for hanging posters, e.g. together with a ceiling magnet. You can find more lengths in our online shop.

Material: metal; Wire thickness: 2 mm; Length: 500 mm
24.0009.8



Hanging Magnet

In plastic casing; Rectangular;
 Colour: white; Width: 25 mm; Length: 52 mm;
 Adhesive force: 7-10 kg; Version: with hooks
24.0053.1

Aktuelle priser findes på vores Webshop

Digital Signage



Digital Pavement Sign "Outdoor"

Advertise both indoors and outdoors. Light rain (IP 54) does not affect the solid pavement sign. Even gusts of wind cannot easily knock over the 45 kg advertising unit. In extreme weather conditions such as heavy rain, heat or storms, simply roll the customer stopper into the safety of your business premises. Thanks to the strong castors, this can be done in no time at all. A slight tilt of the display allows quick relocation. Long business days of up to 14 hours are easily supported by the battery.

Casing material: glass / metal; Colour: black;
 Monitor size: 101,60 cm (40"); Width: 420 mm;
 Height: 1000 mm; Depth: 560 mm; Weight: 45 kg;
 File type: JPEG, BMP, PNG, MP3, MPEG I/II/IV, H264;
 Memory type: USB; Playback type: 9:16; Speaker: optional;
 Internal memory: no; Range of use: for indoor and outdoor use;
 Resolution: 1080 x 1920 pixels; Touchscreen: no;
 Brightness: 500 cd/m²; Connectivity: USB;
 Autostart function: yes
89.0002.189

1. Lockable wheels prevents theft.



1

NEW

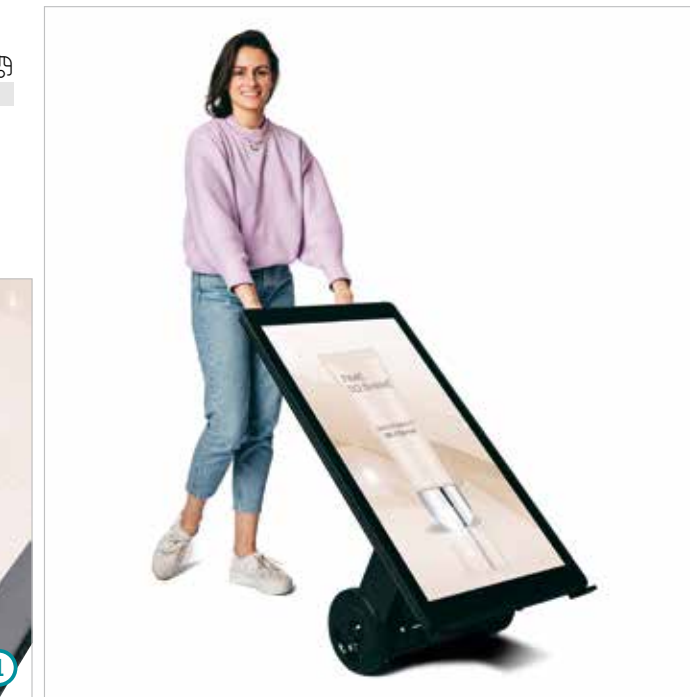

5

Større udvalg findes på : www.vkf-renzel.dk

NEW



Shop Window Screen FLASH.movie "PRO Double Air", double-sided

Doublesided screen in portrait format for ceiling hanging with 2 different brightnesses, where one side offers a brightness of 450 cd/m² and another 700 cd/m² (43") or 800 cd/m² (55"). This makes it ideal for use in an entrance area or display window without having a bright display inside. With an Android operating system, wireless LAN and the software included, content can be displayed from an existing PC without connecting a network cable. It can also be used standalone where the data is loaded from a US to the internal memory. The white casing is suitable for nearly every environment. Fixings for ceiling hanging with steel cables are included in the delivery.

Casing material: metal; Colour: white;
File type: MPEG, MP4, AVI, MOV, JPEG, BMP, MP3, AAC uvm.;
Memory type: USB, HDMI Input; Playback type: 9:16;
Speaker: integrated; Internal memory: 8GB;
Range of use: indoor area; Resolution: 1080 x 1920 pixels;
Connectivity: HDMI, VGA, USB, SD card; Network: LAN, WiFi;
Autostart function: yes

Monitor size: 109.5 cm (43"); Width: 635 mm; Height: 1178 mm;
Depth: 23 mm; Weight: 18.0 kg; Brightness: 700 / 450 cd/m²

89.0002.147

Monitor size: 139.70 cm (55"); Width: 827.4 mm;
Height: 1572.8 mm; Depth: 23.5mm; Weight: 33.5 kg;
Brightness: 800 / 450 cd/m²

89.0002.148

NEW



Digital Info Stand "Attract Mini"

Digital info stele with a 15.6" portrait format screen as a modern and cost-effective way to display your products. The built-in media player with optional battery power give this the flexibility to use at exhibitions or on the move. The lifespan can be extended by using a motion sensor. An HDMI Aconnection allows connection of external players. The wheel sets mean you can move the stele to wherever it is needed.

Casing material: metal / wood / plastic;
Monitor size: 39.62 cm (15.6"); Width: 257 mm;
Height: 1125 mm; Depth: 505 mm; Weight: 8.0 kg;
File type: MPEG, MP4, AVI, MOV, JPEG, BMP, MP3, AAC uvm.;
Memory type: USB; Playback type: 9:16; Speaker: integrated;
Internal memory: no; Resolution: 1080 x 1920 pixels;
Brightness: 220 cd/m²; Connectivity: HDMI, USB;
Autostart function: yes

Colour: black; Touchscreen: no

89.0002.120

Colour: white; Touchscreen: no

89.0002.121

Colour: black; Touchscreen: capacitive

89.0002.122

Colour: white; Touchscreen: capacitive

89.0002.123

For use as a touchscreen an external mini PC is required (Android / Windows)!

Corresponding accessories can be found in our online shop.

Aktuelle priser findes på vores Webshop



Outdoor Advertising

| Outdoor Signage |

6





Bicycle Stand

Ideal for frequently changed advertising. Holds bikes on one or both sides (including mountain bikes). Galvanised coating protects against corrosion. Easy to move about via fitted castors.

Material: metal; Surface: zinc-plated;
Width: 1050 mm; Height: 1750 mm;
Depth: 1250 mm with stabiliser
(storage depth: 3200 mm);
Number of parking spaces: 6 spaces;
Promotional panel: double-sided A1 landscape;
Features: with aluminium click frame and anti-tip
53.0179.1

Beach Flag "Drop"

The classic and top seller among the beach flags.

Rod material: fibreglass / aluminium;
Rod colour: black;
Flag material: Polyester 90 g/m²;
Print method: digital print, 1-sided;
Floor fixing material: steel;
Surface: powder coated; Shape: round;
Diameter: 480 mm; Version: frame incl. bag and digitally printed flag;
Features: incl. transport bag;
Features 2: incl. rotating fixture;
Floor fixing: round base plate 12.5kg, silver

Total height: 2300 mm;
Pole length: 3300 mm;
Flag width: 1047 mm;
Flag height: 1872 mm
80.1010.2

Total height: 3300 mm;
Pole length: 4300 mm;
Flag width: 1138 mm;
Flag height: 2812 mm
80.1010.13

Total height: 4200 mm;
Pole length: 5200 mm;
Flag width: 1157 mm;
Flag height: 3760 mm
80.1010.20



Aktuelle priser findes på vores Webshop

LED Windsign "Seal plus"

Material: aluminium / acrylic / plastic; Surface: anodised;
Colour: black; Mount colour: black; Colour of base: black;
Insert size: A1; Size of visible area: 568 x 817 mm (W x H);
Outer size: 658 x 907 mm (W x H);
Total height (assembled): 1223 mm;
Size of base: 740 x 190 x 630 mm; Illumination: LEDs;
Battery run time: about 24 hours in ECO mode;
Charging time: approx. 5 hours; Coverage: double-sided;
Waterproof: yes
10.0305.5

1. Battery compartment.



Waterproof WindSign "Seal", 44 mm profile, double-sided, with mitred corners, silver/grey

- Plastic base fillable with water or sand
- With spring technology for stability even in "stormy" weather
- Moveable on the integrated wheels
- Mitred corners with silver plastic stoppers on the points
- 2-sided incl. anti-reflective, UV-stabilised cover sheets and plastic back panel
- Available with header board for 1+ pieces
- Assembled by screwing together the frame and the plastic base

Insert size: A1 (594 x 841 mm); Orientation: portrait;
Waterproof: yes
50.0298.2

Exclusively for paper inserts.

Retrofitting with a header board is not possible.
Available with a header board for 1+ pieces.



Større udvalg findes på : www.vkf-renzel.dk



Waterproof A Board "Eco 35"

- Waterproof through rubber seal surround on the back panels and special profile technology
- Weather resistant polystyrene back panels and anti-reflective, UV-stabilised cover sheets
- Accessories such as header boards or wire hanging baskets are available as optional extras
- Custom finishes for 1+ pieces
- RAL powder coated upper profile and / or frame for 1+ pieces

Insert size: A0 (841 x 1189 mm); Orientation: portrait;
Waterproof: yes; Total height: 1330 mm
50.0155.3

More waterproof pavement signs can be found in our webshop.



Banner Frame Slot System Steel "Fascia Entrance"

Excellent as a signpost or info sign.
For advertising space: 1240 x 1035 mm (W x H),
incl. 2 ground spikes; Colour: grey similar to RAL 9006;
Surface: hot-dip galvanised and grey painted; Colour: grey;
Width: 1340 mm; Height: 1670 mm; Depth: 42 mm
15.0041.9

- Digitally printed sign not included.
- Also available in other sizes.
- Corresponding digitally printed sign can be found at www.vkf-renzel.dk.

Aktuelle priser findes på vores Webshop

Stainless Steel Banner Holder INOX "Beam"

Bracket at 90° angle to wall for mounting banners.
The construction prevents flapping and sagging of the banner.

Material: stainless steel; Tube diameter: 33.8 mm;
Diameter of hem: 50 mm; Fixing: 4 holes

15.0189.21
Banner width: 500 mm; Profile width: 680 mm;
Length: max. 4500 mm

15.0189.1
Banner width: 600 mm; Profile width: 770 mm;
Length: max. 4500 mm

15.0189.2
Banner width: 800 mm; Profile width: 965 mm;
Length: max. 2800 mm

15.0189.3
Banner width: 1000 mm; Profile width: 1165 mm;
Length: max. 1900 mm

15.0189.4
Banner width: 1200 mm; Profile width: 1365 mm;
Length: max. 1400 mm

15.0189.4

According to structural analysis based on German standards,
the following maximum canvas lengths (incl. seam) have been
calculated for outdoor use:

- Up to 8 m above ground:**
- Max. banner length for 600 mm banner width = 4500 mm.
 - Max. banner length for 800 mm banner width = 2800 mm.
 - Max. banner length for 1000 mm banner width = 1900 mm.
 - Max. banner length for 1200 mm banner width = 1400 mm.

- Up to 15 m above ground:**
- Max. banner length for 600 mm banner width = 2800 mm.
 - Max. banner length for 800 mm banner width = 1800 mm.
 - Max. banner length for 1000 mm banner width = 1200 mm.
 - Max. banner length for 1200 mm banner width = 900 mm.

1. A: Length + 160 mm
B: Length
C: Banner width
D: Holes ø 13 mm
E: Banner width + 160 mm

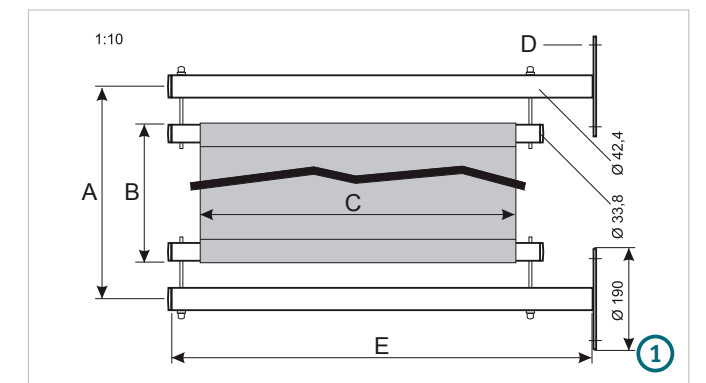

Corresponding digitally printed banners can be found at www.vkf-renzel.dk.

Større udvalg findes på : www.vkf-renzel.dk





bannergear® "Wall"

Frame for wall mounting, incl. crank for easy banner exchange; Also available in special sizes; Max. frame size 6000 x 3000 mm (W x H); Delivery without digitally print banner;

Frame material: aluminium;
Surface: anodised; Frame colour: silver;
Frame depth: 96 mm; Finish: incl. cable, carabiner and removable handle;
Version: for direct wall-mounting

Frame width (outer size): 3000 mm;
Frame height (outer size): 1500 mm;
Banner size: 2800 x 1300 mm (W x H);
Size of visible area:
2720 x 1220 mm (W x H) 

15.0262.6
Frame width (outer size): 4000 mm;
Frame height (outer size): 2000 mm;
Banner size: 3800 x 1800 mm (W x H);
Size of visible area:
3720 x 1720 mm (W x H) 

15.0262.4
Frame width (outer size): 6000 mm;
Frame height (outer size): 3000 mm;
Banner size: 5800 x 2800 mm (W x H);
Size of visible area:
5720 x 2720 mm (W x H) 

15.0262.1

Systems including LED backlighting can be found at www.vkf-renzel.dk



Giveaways | Name Badges

| Giveaways | Name Badges |



Aktuelle priser findes på vores Webshop



Promotional Items

**Hand Sanitiser in 50 ml Holder**

The 50 ml bottle with different coloured silicone covers is not just an optical eyecatcher! Practical with loop for hanging on a rucksack, pushchair or in the shower: Uses are numerous; Contains: hand gel (other options available); antibacterial; Use without water; Price incl. printed label to body plus setup costs

Colour: red; Contains: hand sanitising gel
40.1596.1

**Disinfection Gel "Clap your Hands", 50 ml**

The gel "Clap your Hands" is ideal for sanitising on the go. It fits in any pocket and protects against pathogens, germs and bacteria. It eliminates 99.9% of bacteria. You can personalise the item with a printed 4c label with your logo or slogan - ideal for use as a promotional item. Pre-printing costs are included in the price.

Effect: bactericidal; Size: 86 mm x 44 mm x 24 mm (H x W x D);
Print / motif: to customer specification;
Contains: hand sanitising gel; Fill quantity: 50 ml
40.1897.1

**Tissues**

10 paper towels; 4-ply; wrapped in film; incl. print on the front of the packaging; minimum quantity: 250 pieces;

Size: 104 x 52 x 25 mm

Number of print colours: 1

40.1158.1

Number of print colours: full colour

40.1158.4

plus machine setup costs.

Aktuelle priser findes på vores Webshop

**Antibacterial Ballpoint Pen "Icon Green"**

The antibacterial plastic surface counteracts the proliferation of pathogenic bacteria. This feature is an absolute plus both with constantly changing users of a ballpoint pen and in general everyday use!

Minimum quantity: 1000 pieces
40.1906.

Promotional printing on request.

**Antibacterial Twist Ballpoint Pen "Effect Green"**

The antibacterial twist-action ballpoint pen not only impresses with its outstanding writing quality, but also has an antibacterial effect. Equipped with a coloured or white stopper;

Minimum quantity: 1000 pcs.
40.1905.

Promotional printing on request.

**Chemist's Bag made of Cotton**

Bag made of 100% Öko-Tex cotton; Dimensions: approx. 220 x 260 mm; with 2 short handles; Available in many different colours
46.0664.

Promotional printing on request.

Større udvalg findes på : www.vkf-renzel.dk

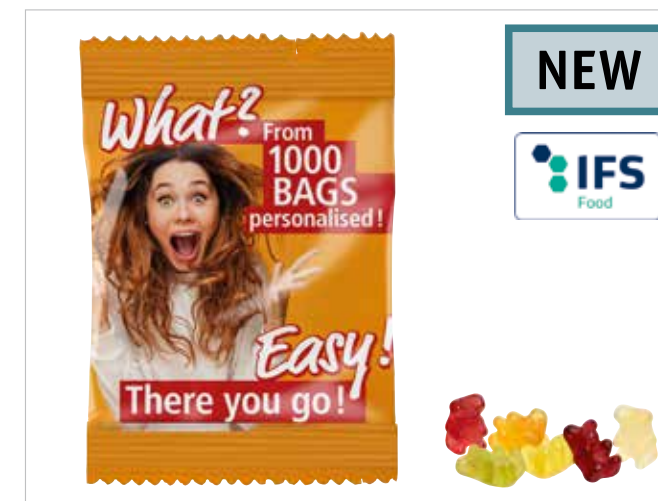
**Easy Bears**

Premium gummy bears mixed in colours and flavours packed in a white glossy laminated promotional bag with 4-colour print. Costs for data processing if data are not provided 1:1, will be charged according to time required.

Sheet colour: white; Contains: approx 10 g; Version: bear; Number of print colours: 1 up to 4 colours
40.1883.1

New, now already available from 1000 pieces.



①

Name Badge "Podio Paper"

This name badge holds a per insert of 76 x 40 mm. It consists of 2 plastic parts and a fixing. The corresponding paper inserts must be ordered separately. The back is available in 10 standard colours and with a choice of 4 fixings. Material: plastic;

Material: plastic; Colour: white; Size of window: 77 x 40 mm; Fixing: with magnet "Premium" (grey) **44.0100.1**

1. Available in different colours.
2. Different fixings available.



②



①



②

Name Badge "Podio Paper Slim"

The new narrower version of our name badge "Podio Paper" fits paper inserts measuring 76 x 26 mm. It consists of two plastic parts and a fixing. The corresponding paper inserts can be ordered separately. The back is available in 3 standard colours and with a choice of 4 fixings.

Material: plastic; Colour: white; Size of window: 77 x 26 mm; Fixing: with magnet "Premium" (grey) **44.0111.1**

Pictures of the silver and gold versions can be found on our website.

1. Magnet "Premium" - 529
2. Magnet "Basic TwentyTwo"
3. Combi-Clip
4. Pin



③

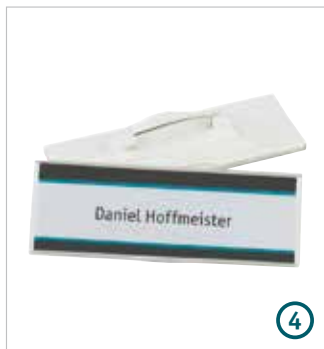

④

Aktuelle priser findes på vores Webshop

Visit our online shop!



Direct ordering
Enter the item code and order.



LIVE Support
Got a question? We're here to help!



Innovation
Discover our new products.



Country specific shops
We're here for you worldwide!



Trade specific products
Use our suggestions for your field of business



Our current T&Cs can be found at www.vkf-renzel.com/content/cos

www.vkf-renzel.dk